

# Amphenol MIL-DTL-5015, Matrix<sup>®</sup>



## TABLE OF CONTENTS

### MIL-DTL-5015, Matrix<sup>®</sup>

- Design Characteristics, Customer Options . . . . . 433
- Insert Availability and Identification . . . . . 434, 435
- Insert Arrangement Drawings . . . . . 436-444
- Class Descriptions, Performance Specifications . . . . . 445
- Insert Alternate Positioning . . . . . 446
- How to Order, Military and Commercial . . . . . 447

### Shell Styles:

- Wall mounting receptacle threaded MS3450 (9440) . . . . . 448
- Cable connecting receptacle threaded MS3451 (9441) . . . . . 449
- Box mounting receptacle threaded MS3452 (9442) . . . . . 450
- Jam nut receptacle threaded MS3454 (9444) . . . . . 451
- Straight plug threaded MS3456 (9446) . . . . . 452
- Straight plug, self-locking threaded MS3459 (9816) . . . . . 453
- Quick disconnect plug push-pull coupling (9817/9818) . . . . . 454
- Matrix<sup>®</sup> 5015 with RADSOK<sup>®</sup> contacts, for high power . . . . . 455
- Contact information, sealing plugs, tools . . . . . 456
- Protection caps, dust caps . . . . . 457-459
- Additional MIL-DTL-5015 connectors offered by Amphenol . . . . . 460



### MIL-DTL-5015, Matrix<sup>®</sup> Typical Markets:

- Military Vehicles
- Heavy Equipment
- Military Aircraft
- Power Generation





**MS3450**  
wall mounting receptacle



**MS3451**  
cable connecting receptacle



**MS3452**  
box mounting receptacle



**MS3454**  
jam nut receptacle



**MS3456**  
plug with threaded coupling



**MS3459**  
plug with self-locking coupling nut

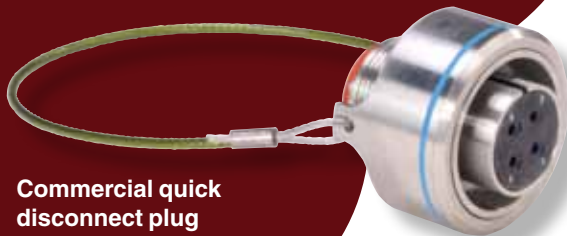

**Commercial quick disconnect plug with/without lanyard**

## Amphenol broadens their MS/Standard family of connectors with the MIL-DTL-5015 Crimp Rear Release Series.

This series provides an alternative to the older MIL-C-5015 solder type. It bridges the gap between an old connector standard and the environmental and high performance needs of current technologies.

### DESIGN CHARACTERISTICS

- Medium to heavy weight cylindrical
- MS345( ) series intermateable with existing MIL-DTL-5015 solder or crimp versions on existing equipment
- Captive coupling nut mechanism, utilizes retaining rings in combination with "L" washers to prevent inadvertent disassembly
- Multiple interlock systems ensure permanent insert retention
- Positive control of dielectric separation with guaranteed ease of contact insertion
- Positive contact retention provided by a closely toleranced damage-proof metal retention clip
- Completely sealed against environmental extremes with -
  - Individual contact seals (conical risers on pin interface)
  - Interfacial seals between contacts
  - Peripheral gasket shell-to-shell seals
  - Redundant rear wire seals and insert-to-shell seals

### CUSTOMER OPTIONS

- Seven mounting styles, in shell sizes 8 to 48\*
- Threaded coupling or self-locking plug (MS3459) with an internal ratcheting mechanism to prevent unmating due to vibration and shock, eliminating the need for safety wiring
- Proprietary quick disconnect plug, with or without lanyard available
- Classes include aluminum or stainless steel shells, or firewall capability
- MS and Proprietary versions available
- Some styles are supplied to McDonnell Douglas Specification BAN 7025, DC60 Series
- Accommodation of contact sizes 0 to 16
- Over 100 insert arrangement patterns available, accommodating from a minimum of 1 to a maximum of 85 circuits
- Alternate positioning available
- Thermocouple pin and socket contacts are available\*\*

NOTE: MIL-C-5015 is superseded to MIL-DTL-5015 for all Amphenol/Matrix rear release crimp type contacts.

\* Consult Amphenol Aerospace for availability of shell sizes 44 and 48.

\*\* Consult Amphenol Aerospace for information on thermocouple contacts.

38999

III
HD
Dualok
II
I
SJT
Accessories
Aquacon
Herm/Seal
PCB

HIGH SPEED
Fiber Optics
Contacts Connectors Cables

EMI Filter Transient

26482 Matrix 2

83723 III Matrix | Pyle

26500 Pyle

5015 Crimp Rear Release Matrix

22992 Class 1

Back-Shell's

Options Others

38999

III  
HD  
Dualok  
II  
I  
SJT  
Accessories  
Aquacon  
Herm/Seal  
PCB

HIGH SPEED  
Fiber Optics  
Contacts  
Connectors  
Cables

EMI Filter  
Transient

26482  
Matrix 2

83723 III  
Matrix | Pyle

26500  
Pyle

5015  
Crimp Rear Release  
Matrix

22992  
Class I

Back-  
Shells

Options  
Others

Insert Arrangement	Service Rating	Total Contacts	Contact Size				
			0	4	8	12	16
8S-1	A	1					1
10S-2	A	1					1
10SL-3	A	3					3
10SL-4	A	2					2
12S-1	A	2					2
12S-2	A	2					2
12S-3	A	2					2
12S-4	D	1					1
12-5	D	1				1	
14S-1**	A	3					3
14S-2	Inst.	4					4
14-3	A	1			1		
14S-5	Inst.	5					5
14S-6	Inst.	6					6
14S-7	A	3					3
14S-9**	A	2					2
14S-10	Inst.	4					4
14S-11	Inst.	4					4
14S-12	A	3					3
14S-13	A	3					3
16S-1	A	7					7
16-2*	E	1				1	
16S-3*	B	1					1
16S-4*	D	2					2
16-7*	A	3			1		2
16S-8	A	5					5
16-9	A	4				2	2
16-10	A	3				3	
16-11	A	2				2	
16-12	A	1		1			
16-13	A	2				2	
18-1	A/Inst.	10					10
18-4	D	4					4
18-5•	D	3				2	1
18-6*	D	1		1			
18-7*	B	1			1		
18-8	A	8				1	7
18-9	Inst.	7				2	5
18-10**	A	4				4	
18-11	A	5				5	
18-12	A	6					6
18-13	A	4			1	3	
18-14*	A	2		1			1
18-15	A	4				4	
18-16*	C	1				1	
18-17	Inst.	7				2	5
18-18	Inst.	7				2	5
18-19**	A	10					10
18-22**	D	3					3

Insert Arrangement	Service Rating	Total Contacts	Contact Size				
			0	4	8	12	16
18-23	A/Inst.	10					10
18-24	A/Inst.	10					10
18-27•	D	3				2	1
18-28•	D	3				2	1
20-2	D	1	1				
20-4	D	4				4	
20-7	D/A	8					8
20-8	Inst.	6			2		4
20-9*	D/A	8				1	7
20-14	A	5			2	3	
20-15	A	7				7	
20-16	A	9				2	7
20-17	A	6				5	1
20-18	A	9				3	6
20-19	A	3			3		
20-21	A	9				1	8
20-22	A	6			3		3
20-24	A	4			2		2
20-27	A	14					14
20-29	A	17					17
20-32	D/A	8					8
20-33	A	11					11
22-2	D	3			3		
22-4**	A	4			2	2	
22-5	D	6				2	4
22-6*	D	3			2		1
22-7*	E	1	1				
22-9*	E	3				3	
22-10*	E	4					4
22-11*	B	2					2
22-12*	D	5			2		3
22-14	A	19					19
22-15*	E/A	6				5	1
22-17*	D/A	9				1	8
22-18*	D/A	8					8
22-19	A	14					14
22-21	A	3	1				2
22-22	A	4			4		
22-23	D/A	8				8	
22-27*	D/A	9			1		8
22-30	A	19					19
22-32	D	6				2	4
22-36*	D/A	8				8	
24-1**	D	2	1			1	
24-2	D	7				7	
24-4*	D	4	1				3
24-5**	A	16					16
24-6*	D/A	8				8	

\* Consult Amphenol Aerospace for availability

\*\* Inactive for new design

• Socket Only

# MIL-DTL-5015 Crimp Rear Release Insert Availability and Identification



38999

Insert Arrangement	Service Rating	Total Contacts	Contact Size				
			0	4	8	12	16
24-7	A	16				2	14
24-10	A	7			7		
24-11	A	9			3	6	
24-12	A	5		2		3	
24-15	A	16					16
24-16*	D/A	7			1	3	3
24-20	D	11				2	9
24-21*	D	10			1		9
24-22	D	4			4		
24-24	A	16					16
24-27*	E	7					7
24-28	Inst.	24					24
24-80*	Inst.	23					23
28-1	D/A	9			3	6	
28-2	D	14				2	12
28-3*	E	3			3		
28-4*	E/D	9				2	7
28-5*	D	5		2		1	2
28-8*	E/D/A	12				2	10
28-9	D	12				6	6
28-10	D/A	7		2	2	3	
28-11	A	22				4	18
28-12	A	26					26
28-13	A	26					26
28-15	A	35					35
28-16*	A	20					20
28-17	B/D/A	15					15
28-18*	C/D/A/Inst.	12					12
28-19*	B/D/A	10				4	6
28-20	A	14				10	4
28-21	A	37					37
28-22	D	6		3			3
32-1	E/D	5	2			3	
32-2*	E	5		3			2
32-3*	D	9	1	2		2	4
32-6	A	23		2	3	2	16
32-7	Inst./A	35				7	28
32-9	D	14		2			12
32-13	D	23				5	18
32-15	D	8	2			6	
32-16	A	23		2	3	2	16
32-17	D	4		4			
32-19	E/D	5	2			3	
32-20	A	23		2	3	2	16

Insert Arrangement	Service Rating	Total Contacts	Contact Size				
			0	4	8	12	16
32-22*	A	54					54
32-63	D	5		5			
32-73	A	46					46
36-3	D	6	3			3	
36-5	A	4	4				
36-6	A	6	2	4			
36-7	A	47				7	40
36-8	A	47				1	46
36-9	A	31		1	2	14	14
36-10	A	48					48
36-11	A	48					48
36-12	A	48					48
36-15	D/A	35					35
36-16	A	47				7	40
36-17	A	47				7	40
36-18	A	31		1	2	14	14
36-21	A	31		1	2	14	14
36-52	A	52					52
36-66*	A	56				4	52
40-1	D	30				6	24
40-2*	D	23					23
40-3*	D	23		1		4	18
40-4*	D	23		2	3	2	16
40-5*	A	15	3	2	4	6	
40-6*	D	26	1			1	24
40-7*	A/D	22	2			2	18
40-9	A	47			1	22	24
40-10*	A	29		4	9		16
40-11*	D	25	1	1	1	4	18
40-56	A	85					85
40-62*	A	60					60

\* Consult Amphenol Aerospace for availability

\*\* Inactive for new design

III  
HD  
Dualok

II  
I

SJT

Accessories  
Aquacon  
Herm/Seal  
PCB

HIGH SPEED

Fiber Optics

Contacts  
Connectors  
Cables

EMI Filter  
Transient

26482  
Matrix 2

83723 III  
Matrix | Pyle

26500  
Pyle

5015  
Crimp Rear  
Release  
Matrix

22992  
Class 1

Back-  
Shells

Options  
Others

38999

- III
- HD
- Dualok
- II
- I
- SJT
- Accessories
- Aquacon
- Herm/Seal
- PCB

Front Face of Pin Insert or Rear Face of Socket Insert Illustrated



Insert Arrangement	8S-1	10S-2	10SL-3	10SL-4	12S-1	12S-2	12S-3
Service Rating	A	A	A***	A	A	A	A
Number of Contacts	1	1	3	2	2	2	2
Contact Size	16	16	16	16	16	16	16

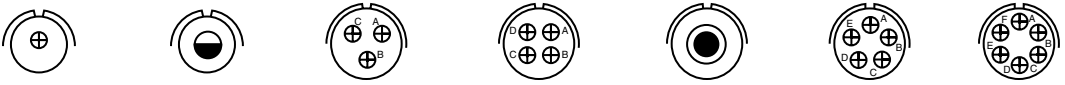

Insert Arrangement	12S-4	12-5	14S-1**	14S-2	14-3	14S-5	14S-6
Service Rating	D	D	A	Inst.	A	Inst.	Inst.
Number of Contacts	1	1	3	4	1	5	6
Contact Size	16	12	16	16	8	16	16

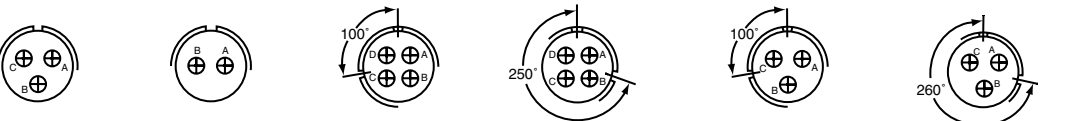

Insert Arrangement	14S-7	14S-9**	14S-10	14S-11	14S-12	14S-13
Service Rating	A	A	Inst.	Inst.	A	A
Number of Contacts	3	2	4	4	3	3
Contact Size	16	16	16	16	16	16

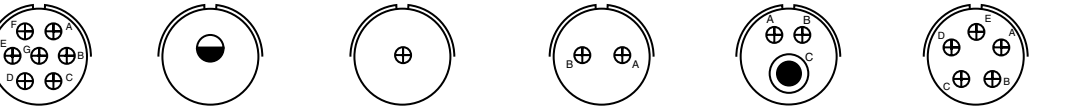

Insert Arrangement	16S-1	16-2*	16S-3*	16S-4*	16-7*	16S-8
Service Rating	A	E	B	D	A	A
Number of Contacts	7	1	1	2	1 2	5
Contact Size	16	12	16	16	8 16	16

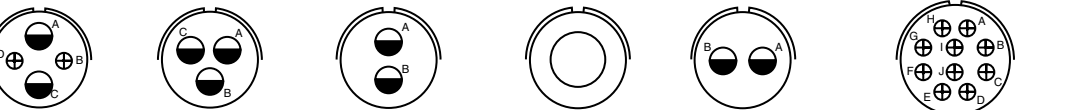

Insert Arrangement	16-9	16-10	16-11	16-12	16-13	18-1
Service Rating	A	A	A	A	A	B, C, F, G = A; Bal. = Inst.
Number of Contacts	2 2	3	2	1	2†	10
Contact Size	12 16	12	12	4	12	16

\* Consult Amphenol Aerospace for availability.  
 \*\* Inactive for new design  
 \*\*\* Service rating Inst. Class K  
 † one Iron contact and one Constantan contact

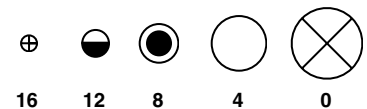



# MIL-DTL-5015 Crimp Rear Release Insert Arrangements

Front Face of Pin Insert or Rear Face of Socket Insert Illustrated



<b>Insert Arrangement</b>	<b>18-4</b>	<b>18-5 •</b>		<b>18-6*</b>	<b>18-7*</b>	<b>18-8*</b>		<b>18-9</b>	
<b>Service Rating</b>	D	D		D	B	A		Inst.	
<b>Number of Contacts</b>	4	2	1	1	1	1	7	2	5
<b>Contact Size</b>	16	12	16	4	8	12	16	12	16

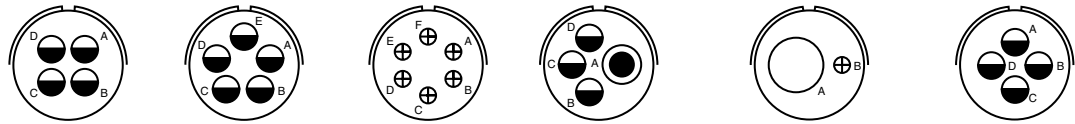

<b>Insert Arrangement</b>	<b>18-10**</b>	<b>18-11</b>		<b>18-12</b>	<b>18-13</b>		<b>18-14*</b>		<b>18-15</b>
<b>Service Rating</b>	A	A		A	A		A		A
<b>Number of Contacts</b>	4	5		6	1	3	1	1	4††
<b>Contact Size</b>	12	12		16	8	12	4	16	12

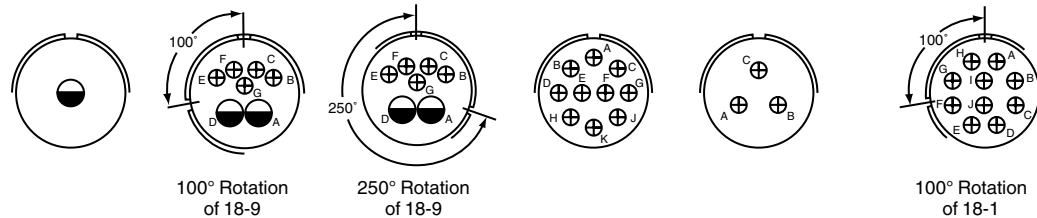

<b>Insert Arrangement</b>	<b>18-16*</b>	<b>18-17</b>		<b>18-18</b>		<b>18-19**</b>	<b>18-22**</b>	<b>18-23</b>	
<b>Service Rating</b>	C	Inst.		Inst.		A	D	B, C, F, G = A; Bal. = Inst.	
<b>Number of Contacts</b>	1	2	5	2	5	10	3	10	
<b>Contact Size</b>	12	12	16	12	16	16	16	16	

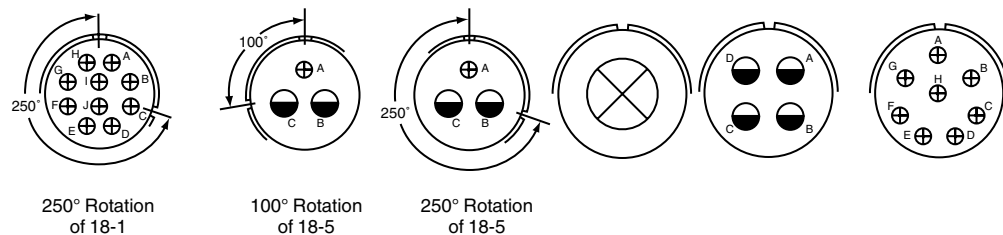

<b>Insert Arrangement</b>	<b>18-24</b>	<b>18-27 •</b>		<b>18-28 •</b>		<b>20-2</b>	<b>20-4</b>	<b>20-7</b>	
<b>Service Rating</b>	B, C, F, G = A; Bal. = Inst.	D		D		D	D	A, B, G, H = D; C, D, E, F = A	
<b>Number of Contacts</b>	10	2	1	2	1	1	4	8	
<b>Contact Size</b>	16	12	16	12	16	0	12	16	

\* Consult Amphenol Aerospace for availability.  
 \*\* Inactive for new design\  
 • Socket only  
 † one Iron contact and one Constantan contact  
 †† A, C = Iron; B, D = Constantan

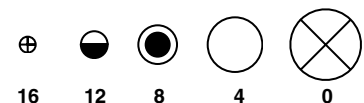

**CONTACT LEGEND**

38999

- III
- HD
- Dualok
- II
- I
- SJT
- Accessories
- Aquacon
- Herm/Seal
- PCB

- HIGH SPEED
- Fiber Optics
- Contacts Connectors Cables

- EMI Filter
- Transient
- 26482
- Matrix 2
- 83723 III
- Matrix | Pyle
- 26500
- Pyle

- 5015
- Crimp Rear Release Matrix
- 22992
- Class 1

- Back-Shell's
- Options
- Others

Front Face of Pin Insert or Rear Face of Socket Insert Illustrated

38999  
III  
HD  
Dualok  
II  
I  
SJT  
Accessories  
Aquacon  
Herm/Seal  
PCB

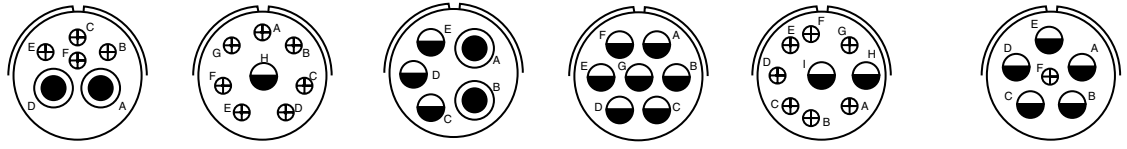

Insert Arrangement	20-8*		20-9*		20-14		20-15		20-16		20-17	
Service Rating	Inst.		H = D; Bal. = A		A		A		A		A	
Number of Contacts	2	4	1	7	2	3	7		2	7	5	1
Contact Size	8	16	12	16	8	12	12		12	16	12	16

HIGH SPEED  
Fiber Optics  
Contacts  
Connectors  
Cables

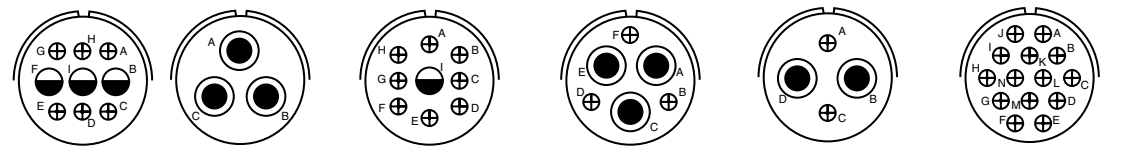

Insert Arrangement	20-18		20-19		20-21		20-22		20-24		20-27	
Service Rating	A		A		A		A		A		A	
Number of Contacts	3	6	3		1	8	3	3	2	2	14	
Contact Size	12	16	8		12	16	8	16	8	16	16	

EMI Filter  
Transient

26482  
Matrix 2

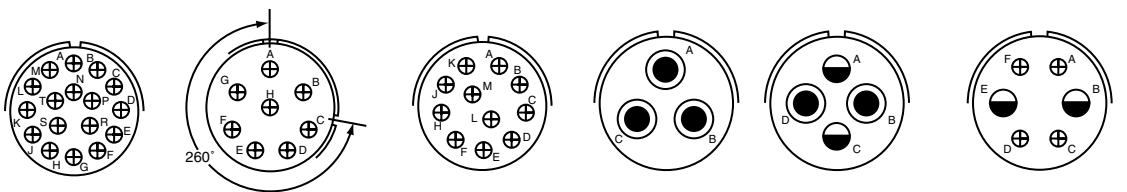

260° Rotation of 20-7

Insert Arrangement	20-29		20-32		20-33		22-2		22-4**		22-5	
Service Rating	A		A, B, G, H = D; Bal. = A		A		D		A		D	
Number of Contacts	17		8		11		3		2	2	2	4
Contact Size	16		16		16		8		8	12	12	16

83723 III  
Matrix | Pyle

26500  
Pyle

5015  
Crimp Rear Release  
Matrix

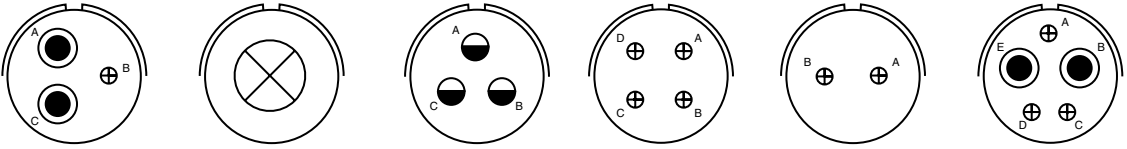

Insert Arrangement	22-6**		22-7*		22-9*		22-10*		22-11*		22-12*	
Service Rating	D		E		E		E		B		D	
Number of Contacts	2	1	1		3		4		2		2	3
Contact Size	8	16	0		12		16		16		8	16

22992  
Class I

Back-  
Shells

Options  
Others

\* Consult Amphenol Aerospace for availability.

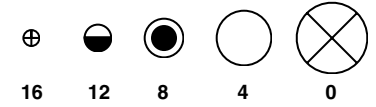

# MIL-DTL-5015 Crimp Rear Release Insert Arrangements

Front Face of Pin Insert or Rear Face of Socket Insert Illustrated

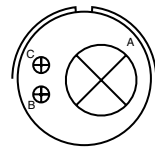
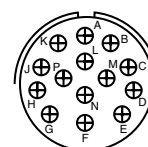
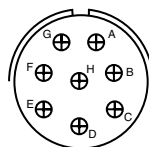
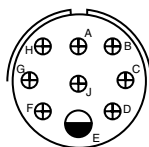
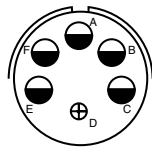
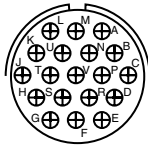

Insert Arrangement	22-14	22-15*		22-17*		22-18*	22-19		22-21	
Service Rating	A	D = 3; Bal. = A		A = D; Bal. = A		C, D, E = A; Bal. = D	A		A	
Number of Contacts	19	5	1	1	8	8	14		1	2
Contact Size	16	12	16	12	16	16	16		0	16

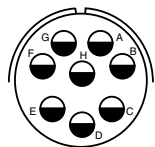
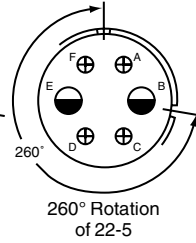
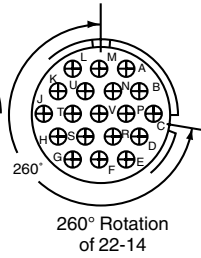
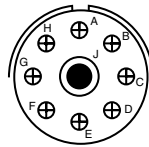
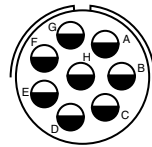
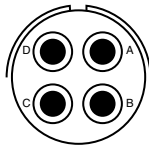

Insert Arrangement	22-22	22-23		22-27*		22-30	22-32		22-36*	
Service Rating	A	H = D; Bal. = A		J = D; Bal. = A		A	D		H = D; Bal. = A	
Number of Contacts	4	8		1		8	19	2	4	8
Contact Size	8	12		8		16	16	12	16	12

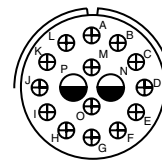
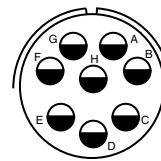
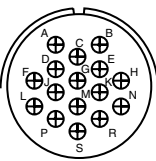
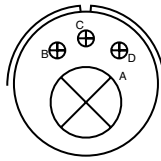
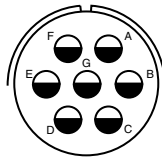
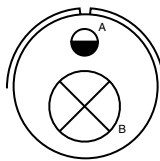

Insert Arrangement	24-1**		24-2		24-4*		24-5**	24-6*		24-7	
Service Rating	D		D		D		A	A, G, H = D; Bal. = A		A	
Number of Contacts	1	1	7	7	1	3	16	8	8	2	14
Contact Size	0	12	12	12	0	16	16	12	12	12	16

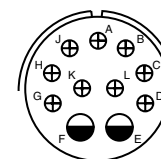
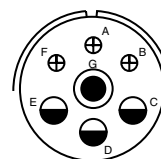
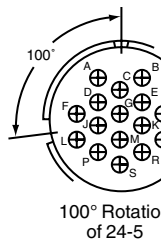
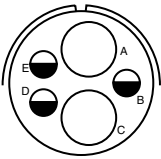
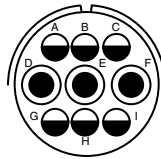
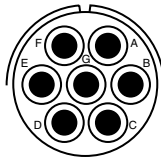

Insert Arrangement	24-10	24-11		24-12		24-15		24-16*			24-20
Service Rating	A	A		A		A		A, B, F, G = D; C, D, E = A			D
Number of Contacts	7	3	6	2	3	16	1	3	3	2	9
Contact Size	8	8	12	4	12	16	8	12	16	12	16

\* Consult Amphenol Aerospace for availability.  
 \*\* Inactive for new design

CONTACT LEGEND

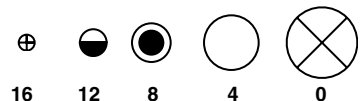

38999

- III
- HD
- Dualok
- II
- I
- SJT
- Accessories
- Aquacon
- Herm/Seal
- PCB

- HIGH SPEED
- Fiber Optics
- Contacts Connectors Cables

EMI Filter  
Transient

26482  
Matrix 2

83723 III  
Matrix | Pyle

26500  
Pyle

5015  
Crimp Rear Release Matrix

22992  
Class 1

Back-Shell's

Options  
Others



38999  
III  
HD  
Dualok  
II  
I  
SJT  
Accessories  
Aquacon  
Herm/Seal  
PCB

Front Face of Pin Insert or Rear Face of Socket Insert Illustrated

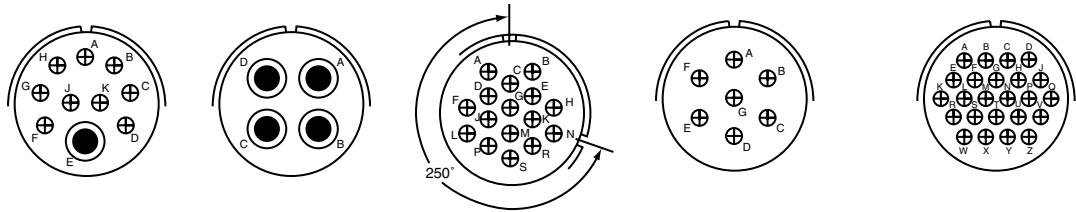

250° Rotation of 24-5

Insert Arrangement	24-21*		24-22		24-24		24-27*		24-28	
Service Rating	D		D		A		E		Inst.	
Number of Contacts	1	9	4	8	16	16	7	16	24	
Contact Size	8	16	8	8	16	16	16	16	16	

HIGH SPEED  
Fiber Optics  
Contacts  
Connectors  
Cables

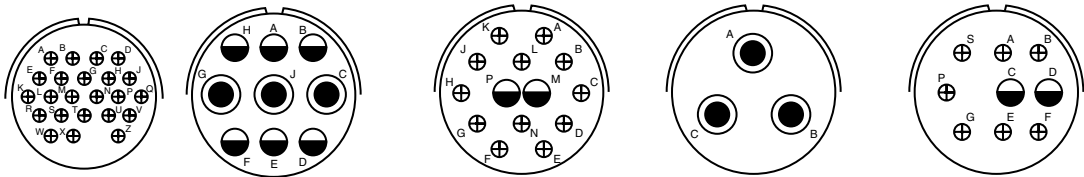

Insert Arrangement	24-80*		28-1		28-2		28-3*		28-4*	
Service Rating	Inst.		A, J, E = D; Bal. = A		D		E		G, P, S = E; Bal. = D	
Number of Contacts	23	16	3	6	2	12	3	8	2	7
Contact Size	16	16	8	12	12	16	8	8	12	16

EMI Filter  
Transient

26482  
Matrix 2

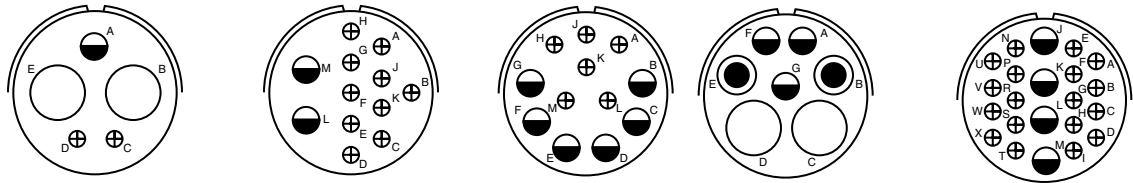

Insert Arrangement	28-5*			28-8*		28-9		28-10			28-11	
Service Rating	D			L, M = E; B = D; Bal. = A		D		G = D, Bal. = A			A	
Number of Contacts	2	1	2	2	10	6	6	2	2	3	4	18
Contact Size	4	12	16	12	16	12	16	4	8	12	12	16

83723 III  
Matrix | Pyle

26500  
Pyle

5015  
Crimp Rear Release  
Matrix

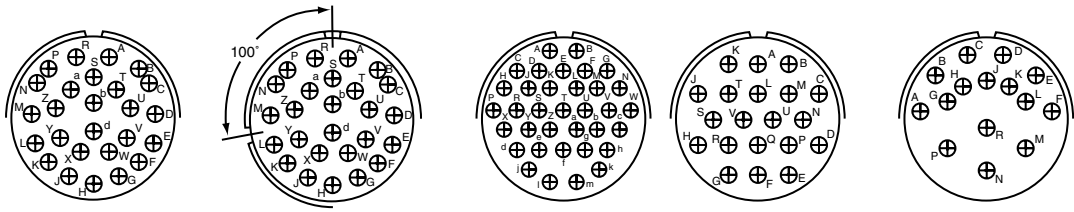

100° Rotation of 28-12

Insert Arrangement	28-12		28-13		28-15		28-16**		28-17	
Service Rating	A		A		A		A		R = B; M, N, P = D; Bal. = A	
Number of Contacts	26		26		35		20		15	
Contact Size	16		16		16		16		16	

22992  
Class I

Back-Shell

Options  
Others

\* Consult Amphenol Aerospace for availability.

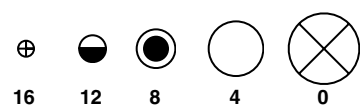

# MIL-DTL-5015 Crimp Rear Release Insert Arrangements

Front Face of Pin Insert or Rear Face of Socket Insert Illustrated

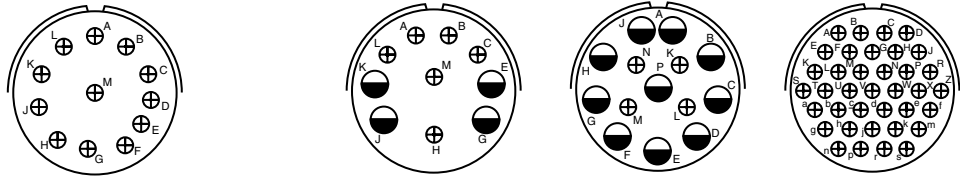

Insert Arrangement	28-18*	28-19*	28-20	28-21
Service Rating	M = C; G, H, J, K, L = D; A, B = A; Bal. = Inst.	H, M = B; A, B = D; Bal. = A	A	A
Number of Contacts	12	4      6	10    4	37
Contact Size	16	12      16	12    16	16

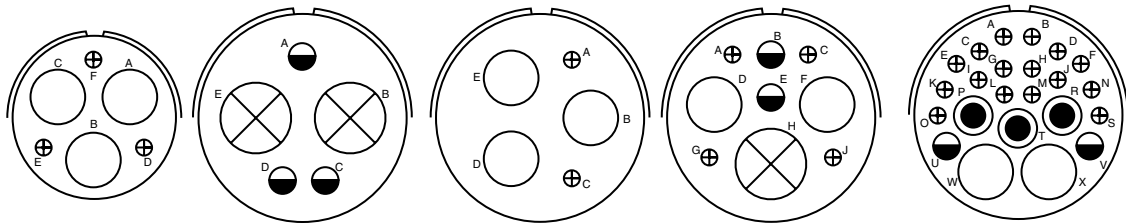

Insert Arrangement	28-22	32-1	32-2*	32-3*	32-6
Service Rating	D	A = E; B, C, D, E = D	E	D	A
Number of Contacts	3    3	2    3	3    2	1    2    2    4	2    3    2    16
Contact Size	4    16	0    12	4    16	0    4    12    16	4    8    12    16

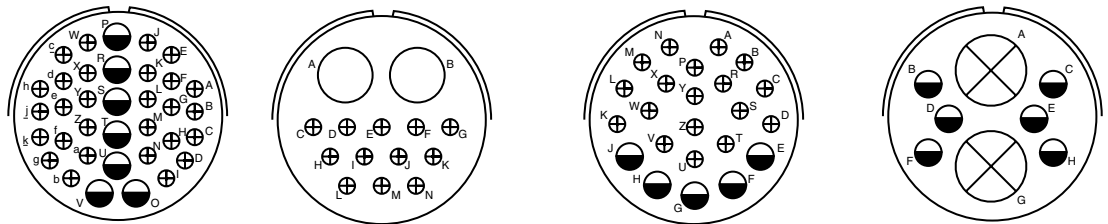

Insert Arrangement	32-7	32-9	32-13	32-15
Service Rating	A, B, h, j = Inst.; Bal. = A	D	D	D
Number of Contacts	7      28	2      12	5      18	2      6
Contact Size	12     16	4      16	12    16	0      12

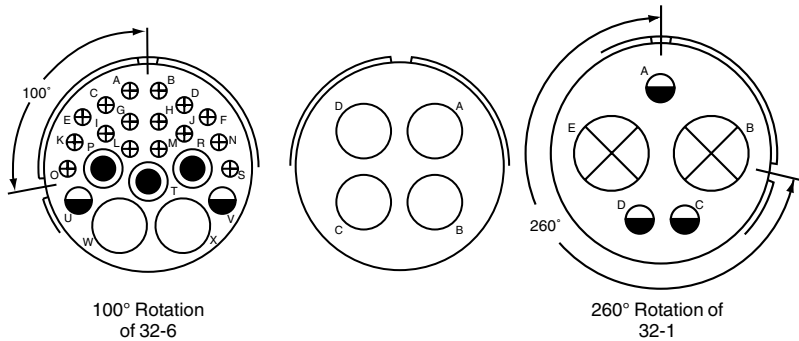

Insert Arrangement	32-16	32-17	32-19
Service Rating	A	D	A = E, Bal. = D
Number of Contacts	2    3    2    16	4	2    3
Contact Size	4    8    12    16	4	0    12

\* Consult Amphenol Aerospace for availability.  
 \*\* Inactive for new design

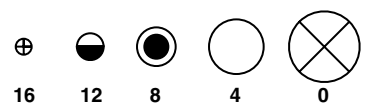

38999

- III
- HD
- Dualok
- II
- I
- SJT
- Accessories
- Aquacon
- Herm/Seal
- PCB

- HIGH SPEED
- Fiber Optics
- Contacts Connectors Cables

EMI Filter  
Transient

26482  
Matrix 2

83723 III  
Matrix | Pyle

26500  
Pyle

5015  
Crimp Rear Release Matrix

22992  
Class 1

Back-Shell's

Options  
Others

Front Face of Pin Insert or Rear Face of Socket Insert Illustrated

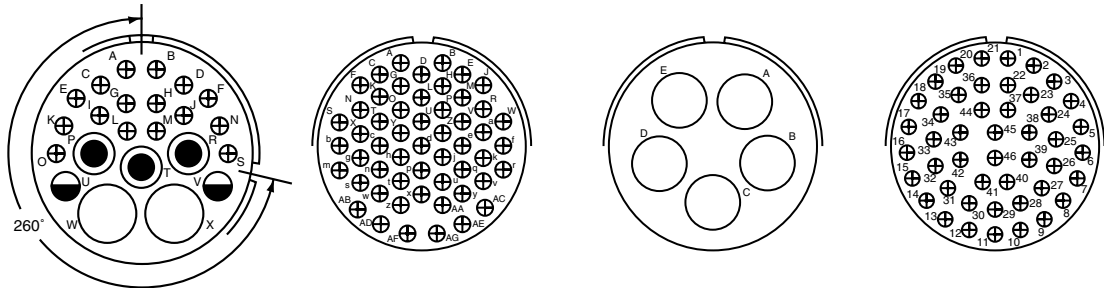

260° Rotation of 32-6

Insert Arrangement	32-20				32-22*				32-63				32-73			
Service Rating	A				A				D				A			
Number of Contacts	2	3	2	16	54				5				46			
Contact Size	4	8	12	16	16				4				16			

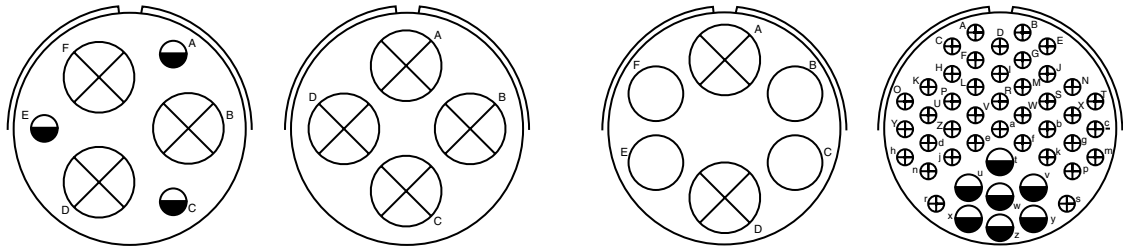

Insert Arrangement	36-3		36-5		36-6		36-7	
Service Rating	D		A		A		A	
Number of Contacts	3	3	4		2	4	7	40
Contact Size	0	12	0		0	4	12	16

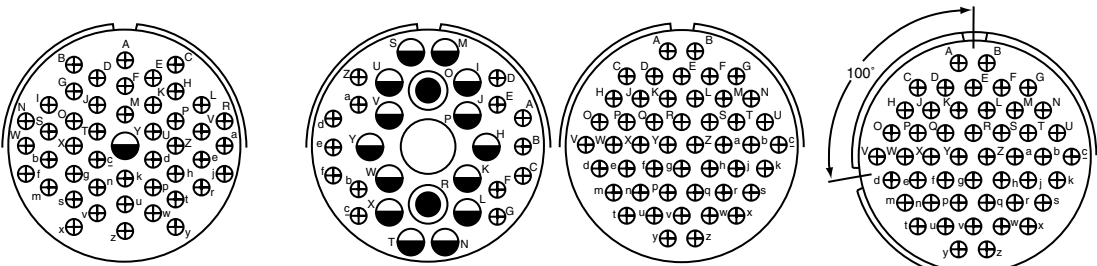

100° Rotation of 36-10

Insert Arrangement	36-8		36-9				36-10		36-11	
Service Rating	A		A				A		A	
Number of Contacts	1	46	1	2	14	14	48		48	
Contact Size	12	16	4	8	12	16	16		16	

\* Consult Amphenol Aerospace for availability.

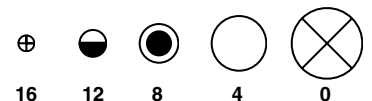

CONTACT LEGEND 16 12 8 4 0

38999  
III  
HD  
Dualok  
II  
I  
SJT  
Accessories  
Aquacon  
Herm/Seal  
PCB

HIGH SPEED  
Fiber Optics  
Contacts  
Connectors  
Cables

EMI Filter  
Transient

26482  
Matrix 2

83723 III  
Matrix | Pyle

26500  
Pyle

5015  
Crimp Rear Release  
Matrix

22992  
Class I

Back-  
Shells

Options  
Others

# MIL-DTL-5015 Crimp Rear Release Insert Arrangements

Front Face of Pin Insert or Rear Face of Socket Insert Illustrated

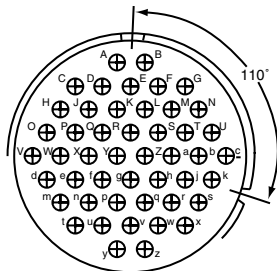

110° Rotation of 36-10

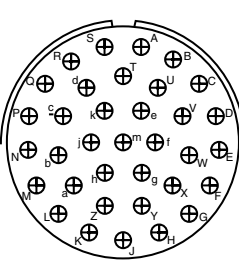

100° Rotation of 36-7

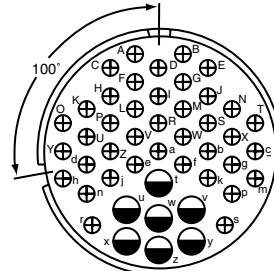

100° Rotation of 36-6

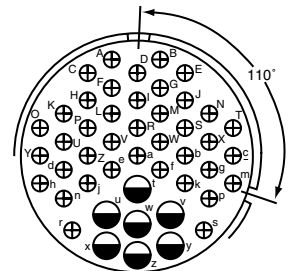

110° Rotation of 36-17

Insert Arrangement	36-12	36-15	36-16		36-17	
Service Rating	A	M = D, Bal. = A	A		A	
Number of Contacts	48	35	7	40	7	40
Contact Size	16	16	12	16	12	16

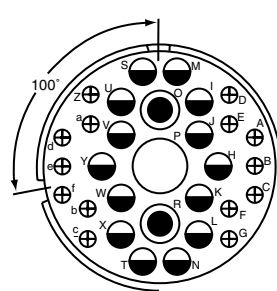

100° Rotation of 36-9

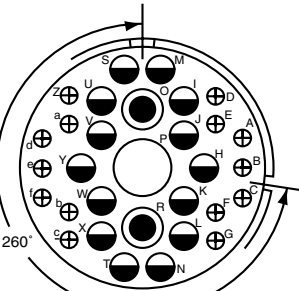

260° Rotation of 36-9

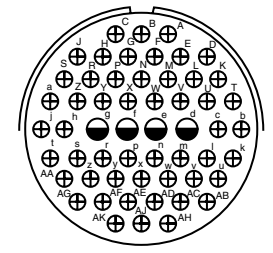
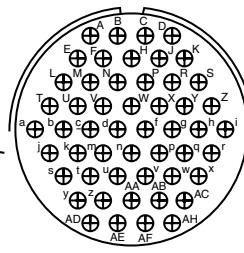

Insert Arrangement	36-18				36-21				36-52	36-66*	
Service Rating	A				A				A	A	
Number of Contacts	1	2	14	14	1	2	14	14	52	4	52
Contact Size	4	8	12	16	4	8	12	16	16	12	16

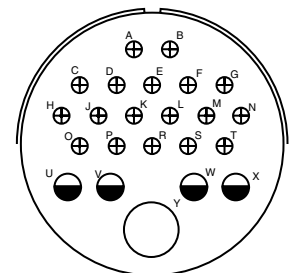
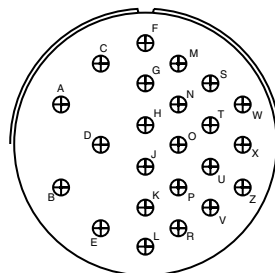
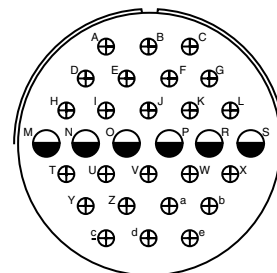

Insert Arrangement	40-1		40-2*	40-3*		
Service Rating	D		D	D		
Number of Contacts	6	24	23	1	4	18
Contact Size	12	16	16	4	12	16

\* Consult Amphenol Aerospace for availability.

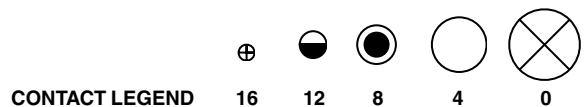

38999

- III
- HD
- Duallok
- II
- I
- SJT
- Accessories
- Aquacon
- Herm/Seal
- PCB

- HIGH SPEED
- Fiber Optics
- Contacts Connectors Cables

EMI Filter Transient

26482 Matrix 2

83723 III Matrix | Pyle

26500 Pyle

5015 Crimp Rear Release Matrix

22992 Class 1

Back-Shell's

Options Others

Front Face of Pin Insert or Rear Face of Socket Insert Illustrated

- 38999
- III
- HD
- Dualok
- II
- I
- SJT
- Accessories
- Aquacon
- Herm/Seal
- PCB

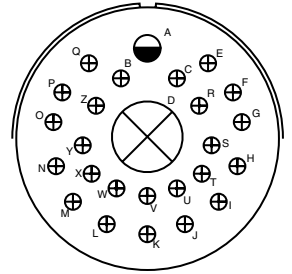
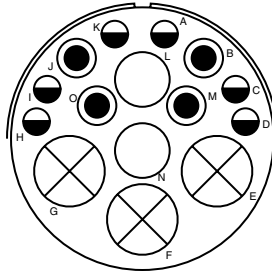
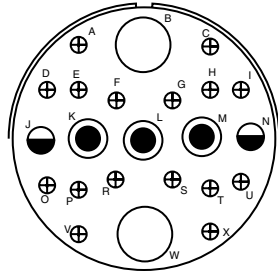

Insert Arrangement	40-4*				40-5*				40-6*		
Service Rating	D				A				D		
Number of Contacts	2	3	2	16	3	2	4	6	1	1	24
Contact Size	4	8	12	16	0	4	8	12	0	12	16

- HIGH SPEED
- Fiber Optics
- Contacts Connectors Cables

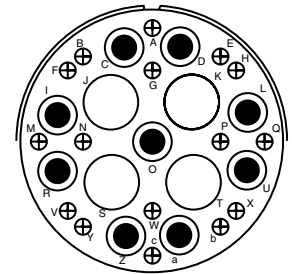
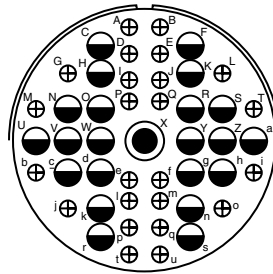
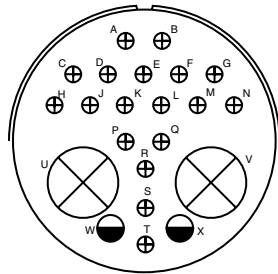

Insert Arrangement	40-7*			40-9			40-10*		
Service Rating	P, Q, U, V, W, X = A; Bal. = D			A			A		
Number of Contacts	2	2	18	1	22	24	4	9	16
Contact Size	0	12	16	8	12	16	4	8	16

- EMI Filter Transient
- 26482 Matrix 2
- 83723 III Matrix | Pyle
- 26500 Pyle

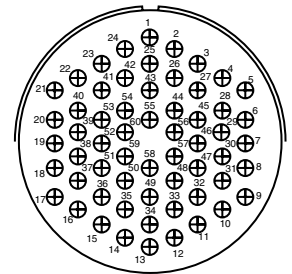
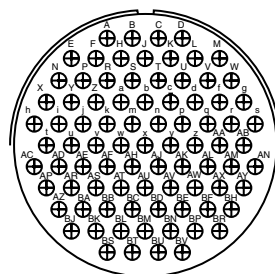
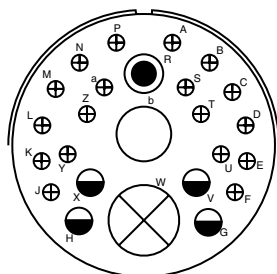

Insert Arrangement	40-11*					40-56	40-62*
Service Rating	D					A	A
Number of Contacts	1	1	1	4	18	85	60
Contact Size	0	4	8	12	16	16	16

- 5015 Crimp Rear Release Matrix
- 22992 Class I
- Back-Shells
- Options Others

\* Consult Amphenol Aerospace for availability.

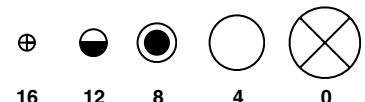



# MIL-DTL-5015 Crimp Rear Release

## Class Descriptions, Performance Specifications

### CLASS DESCRIPTIONS

Military MIL-DTL-5015	
Class L*	Aluminum shell, electroless nickel finish, fluid resistant insert
Class W	Aluminum shell, cadmium olive drab finish, fluid resistant insert
Class LS	Stainless steel shell, passivated, fluid resistant insert
Class KT**	Firewall, steel shell, cadmium olive drab finish, non-flammable hard dielectric and fluid resistant insert
Class KS	Firewall, stainless steel shell, passivated, non-flammable hard dielectric and fluid resistant insert

Amphenol/Matrix	
Class A	Aluminum shell, black anodize finish, fluid resistant insert
Class F	Aluminum shell, electroless nickel finish, fluid resistant insert
Class W	Aluminum shell, cadmium/olive drab finish, fluid resistant insert
Class FS	Stainless steel shell, passivated, fluid resistant insert
Class KT	Firewall, steel shell, cadmium olive drab finish, non-flammable hard dielectric and fluid resistant insert
Class KS	Firewall, stainless steel shell, passivated, non-flammable hard dielectric and fluid resistant insert

\* Class L inactivates older Class U (aluminum, electroless nickel)

\*\* Class KT (ferrous alloy, cadmium/olive drab) inactivates older Class K (ferrous alloy, electroless nickel)

### PERFORMANCE SPECIFICATIONS

#### VOLTAGE RATING

Altitude	Inst.	A	D	E	B	C
Sea Level	1000	2000	2800	3500	4500	7000
50,000 ft.	400	600	675	750	825	975
70,000 ft.	260	360	400	440	480	560
110,000 ft.	200	200	200	200	200	200

### SHOCK

Wired, mated connectors are subjected to one shock in each of three mutually perpendicular axes with pulse of an approximate half sine wave of 50g magnitude for a duration of 11 milliseconds. All contacts wired in series circuit with 100 ±10 Milliampères of current flow.

### OPERATING TEMPERATURE RANGE

Classes L, LS and KS have temperature range of -55°C (-75°F) to 200°C (392°F)

Classes W and KT have temperature range of -55°C (-75°F) to 175°C (347°F)

### ENVIRONMENTAL SEAL

Wired, mated connectors with the specified accessory attached will meet the altitude immersion test specified in MIL-DTL-5015.

### DURABILITY

Minimum of 100 mating cycles.

38999

- III
- HD
- Dualok
- II
- I
- SJT
- Accessories
- Aquacon
- Herm/Seal
- PCB

- HIGH SPEED
- Fiber Optics
- Contacts Connectors Cables

- EMI Filter
- Transient

- 26482
- Matrix 2

- 83723 III
- Matrix | Pyle

- 26500
- Pyle

- 5015
- Crimp Rear Release Matrix

- 22992
- Class I

- Back-Shells

- Options Others

38999

To avoid cross-plugging problems in applications requiring the use of more than one connector of the same size and arrangement, alternate rotations are available as indicated in the accompanying charts.

As shown in the diagram below, the front face of the pin insert is rotated within the shell in a clockwise direction from the normal shell key. The socket insert would be rotated counter-clockwise the same number of degrees in respect to the normal shell key.

The charts give the W, X, Y, Z positions for the alternate rotations available for the insert arrangements of the rear release MIL-DTL-5015 series of connectors. If an insert arrangement number is not given, then there is no available alternate rotation for that pattern.

The following insert arrangements have the same alternate insert rotations for W, X, Y and Z, which are:

Degrees			
W	X	Y	Z
80	110	250	280

16-7	20-22	24-4	28-4	28-21	40-3
18-5	22-6	24-5	28-8	32-1	40-4
18-9	22-12	24-6	28-9	32-3	40-5
18-13	22-14	24-7	28-10	32-6	40-6
18-14	22-15	24-12	28-11	32-9	40-7
20-7	22-17	24-16	28-15	32-13	40-11
20-8	22-18	24-20	28-16	32-22	
20-9	22-19	24-21	28-17	36-7	
20-14	22-21	24-28	28-19	36-8	
20-16	24-1	28-1	28-20	40-2	

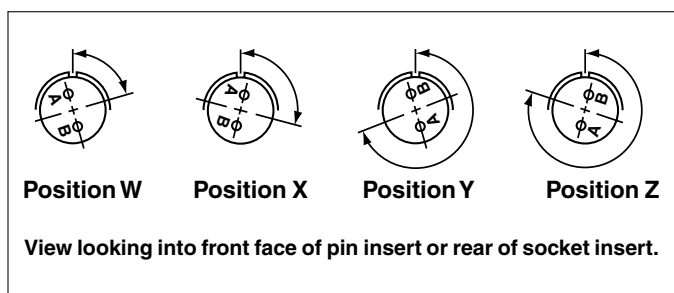

Insert Arrangement	Degrees			
	W	X	Y	Z
12S-3	70	145	215	290
14S-2	-	120	240	-
14S-5	-	110	-	-
14S-7	90	180	270	-
14S-9	70	145	215	290
16S-1	80	-	-	280
16S-4	35	110	250	325
16S-8	-	170	265	-
16-9	35	110	250	325
16-10	90	180	270	-
16-11	35	110	250	325
16-13	35	110	250	325
18-1	70	145	215	290
18-4	35	110	250	325
18-8	70	-	-	290
18-10	-	120	240	-
18-11	-	170	265	-
18-12	80	-	-	280
18-15	-	120	240	-
18-19	-	120	240	-
18-22	70	145	215	290
20-4	45	110	250	-
20-15	80	-	-	280

Insert Arrangement	Degrees			
	W	X	Y	Z
20-17	90	180	270	-
20-18	35	110	250	325
20-19	90	180	270	-
20-21	35	110	250	325
20-24	35	110	250	325
20-27	35	110	250	325
20-29	80	-	-	280
22-2	70	145	215	290
22-4	35	110	250	325
22-5	35	110	250	325
22-9	70	145	215	290
22-10	35	110	250	325
22-11	35	110	250	325
22-22	-	110	250	-
22-23	35	-	250	-
22-27	80	-	250	280
22-36	90	-	270	-
24-2	80	-	-	280
24-10	80	-	-	280
24-11	35	110	250	325
24-22	45	110	250	-
24-27	80	-	-	280
24-80	35	145	240	300

Insert Arrangement	Degrees			
	W	X	Y	Z
28-2	35	110	250	325
28-3	70	145	215	290
28-5	35	110	250	325
28-12	90	180	270	-
28-18	70	145	215	290
28-22	70	145	215	290
32-2	70	145	215	290
32-7	80	125	235	280
32-15	35	110	250	280
32-17	45	110	250	-
32-73	36	-	-	-
36-3	70	145	215	290
36-5	-	120	240	-
36-6	35	110	250	325
36-9	80	125	235	280
36-10	80	125	235	280
36-15	60	125	245	305
36-52	72	144	216	288
36-66	110	250	260	280
40-1	65	130	235	300
40-9	65	125	255	310
40-10	65	125	255	310
40-56	72	144	216	288
40-62	30	130	220	290

# MIL-DTL-5015 Crimp Rear Release

## How to Order

	1.	2.	3.	4.	5.	6.	7.
MIL-DTL-5015 with rear release crimp contacts	Connector Type	Shell Style	Service class	Shell Size-Insert Arrangement	Contact Types	Alternate Positions	Modification Number
<b>MILITARY</b>	<b>MS</b>	<b>3456</b>	<b>L</b>	<b>16S-8</b>	<b>P</b>	<b>W</b>	<b>NA</b>
<b>COMMERCIAL</b>	<b>944</b>	<b>6</b>	<b>F</b>	<b>16S-8</b>	<b>P</b>	<b>W</b>	<b>(XXX)</b>

### Step 1. Military Connector Type

<b>MS</b>	Designates Military Standard
-----------	------------------------------

### Step 2. Select a Shell Style

#### THREADED COUPLING CONNECTORS

<b>3450</b>	Wall mounting receptacle
<b>3451</b>	Cable connecting receptacle
<b>3452</b>	Box mounting receptacle
<b>3454</b>	Jam nut receptacle
<b>3456</b>	Straight plug
<b>3459</b>	Straight plug with self-locking coupling nut

### Step 3. Select a Service Class

<b>L</b>	Aluminum shell, electroless nickel finish, fluid resistant insert
<b>W</b>	Aluminum shell, cadmium olive drab finish, fluid resistant insert
<b>LS</b>	Stainless steel shell, passivated, fluid resistant insert
Firewall Styles only available for 3450, 3456, 3459 per mil spec:	
<b>KT</b>	Firewall, steel shell, cadmium/olive drab finish, non-flammable hard dielectric and fluid resistant insert
<b>KS</b>	Firewall, stainless steel shell, passivated, non-flammable hard dielectric and fluid resistant insert

Note: Class L inactivates older Class U.

Class K is inactive and has been replaced by Class KT for all applications.

### Step 4. Select a Shell Size & Insert Arrangement see pages 434, 435

First number represents Shell Size, second number is the Insert Arrangement.

### Step 5. Select a Contact Type

	Designates
<b>P</b>	Pin
<b>S</b>	Socket
<b>A</b>	Less pins
<b>B</b>	Less sockets

### Step 6. Alternate Positions

“W”, “X”, “Y”, “Z” designate that insert is rotated in its shell from normal position. No letter required for normal (no rotation) position. See page 446 for description of alternate positions.

### Step 1. Select a Commercial Connector Type

<b>944</b>	Designates Amphenol/Matrix Commercial Series
<b>981</b>	Designates self locking/Quick disconnect (+)(-) lanyard

### Step 2. Select a Shell Style

#### THREADED COUPLING CONNECTORS

<b>0</b>	Wall mounting receptacle
<b>1</b>	Cable connecting receptacle
<b>2</b>	Box mounting receptacle
<b>4</b>	Jam nut receptacle
<b>6</b>	Straight plug
Self Locking/Quick disconnect (981) styles:	
<b>6</b>	Straight plug with self-locking coupling nut
<b>7</b>	Quick disconnect plug with lanyard
<b>8</b>	Quick disconnect plug without lanyard

### Step 3. Select a Service Class

<b>A</b>	Aluminum shell, black anodize finish, fluid resistant insert (not MIL-Spec)
<b>F</b>	Aluminum shell, electroless nickel finish, fluid resistant insert
<b>W</b>	Aluminum shell, cadmium olive drab finish, fluid resistant insert
<b>FS</b>	Stainless steel shell, passivated, fluid resistant insert
<b>RS</b>	Fluid resistant insert
<b>KT</b>	Firewall, steel shell, cadmium/olive drab finish, non-flammable hard dielectric and fluid resistant insert
<b>KS</b>	Firewall, stainless steel shell, passivated, non-flammable hard dielectric and fluid resistant insert

### Step 4. Select a Shell Size & Insert Arrangement see pages 434, 435

First number represents Shell Size, second number is the Insert Arrangement.

### Step 5. Select a Contact Type

	Designates
<b>P</b>	Pin
<b>S</b>	Socket

### Step 6. Alternate Positions

“W”, “X”, “Y”, “Z” designate that insert is rotated in its shell from normal position. No letter required for normal (no rotation) position. See page 446 for description of alternate positions.

### Step 7. Modification Number

Consult Amphenol Aerospace for information.

For strain reliefs use the following modification codes:

- (189) E-nut M85049/31 configuration
- (190) Straight strain relief M85049/52 configuration
- (191) 90° strain relief M85049/51 configuration

38999

III

HD

Dualok

II

I

SJT

Accessories

Aquacon

Herm/Seal

PCB

HIGH SPEED

Fiber Optics

Contacts  
Connectors  
Cables

EMI Filter  
Transient

26482  
Matrix 2

83723 III  
Matrix | Pyle

26500  
Pyle

5015  
Crimp Rear  
Release  
Matrix

22992  
Class 1

Back-Shell's

Options  
Others

**PART # Receptacle Shell, Flange Wall Mount, Threaded Coupling.**  
To complete, see how to order page 447

MIL-DTL-5015	Connector Type	Shell Style	Service Class	Shell Size-Insert Arrangement	Contact Type	Alternate Rotation	Modification Number
<b>Military</b>	<b>MS</b>	<b>3450</b>	<i>L</i>	<i>16S-8</i>	<i>P</i>	<i>W</i>	<b>NA</b>
<b>Commercial</b>	<b>944</b>	<b>0</b>	<i>F</i>	<i>16S-8</i>	<i>P</i>	<i>W</i>	<i>xxx</i>

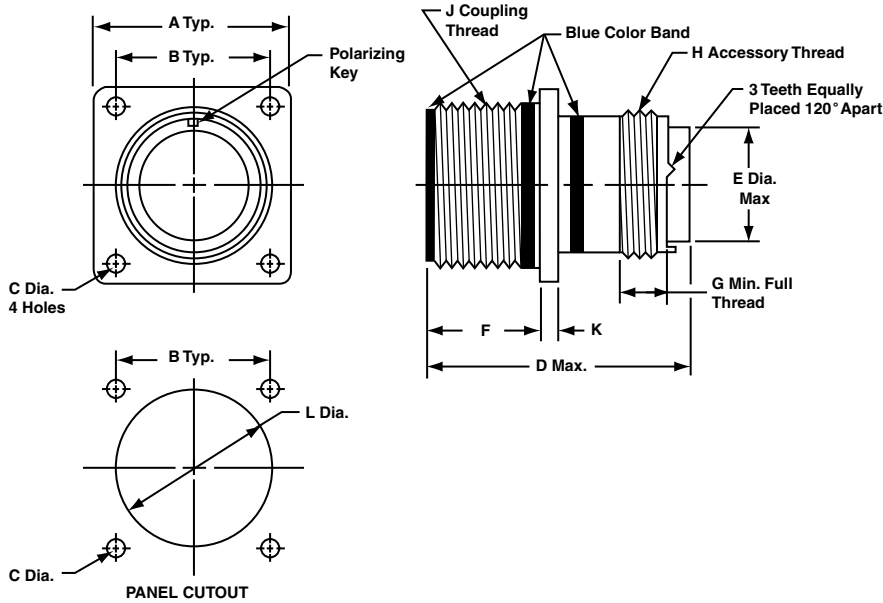

Shell Size*	A ±.031	B	C Dia. +.010 -0.005		D Max.		E Dia. Max.	F	G Min.	H Thread Class 2A	J Thread Class 2A	K	L Dia. ±.010
			Class A, F, R, W	Class K	Size 16 & 12 Contacts	Size 8, 4, 0 Contacts							
8S	.875	.594	.120	.150	2.031	—	.305	.593/.562	.290	.5000-20 UNEF	.5000-28 UNEF	.083	.562
10S	1.000	.719	.120	.150	2.031	—	.405	.593/.562	.290	.6250-24 UNEF	.6250-24 UNEF	.083	.688
10SL	1.000	.719	.120	.150	2.031	—	.405	.593/.562	.290	.6250-24 UNEF	.6250-24 UNEF	.083	.688
12	1.094	.812	.120	.150	2.125	—	.549	.781/.750	.290	.7500-20 UNEF	.7500-20 UNEF	.083	.812
12S	1.094	.812	.120	.150	2.031	—	.549	.593/.562	.290	.7500-20 UNEF	.7500-20 UNEF	.083	.812
14	1.188	.906	.120	.150	2.125	—	.665	.781/.750	.290	.8750-20 UNEF	.8750-20 UNEF	.083	.938
14S	1.188	.906	.120	.150	2.031	—	.665	.593/.562	.290	.8750-20 UNEF	.8750-20 UNEF	.083	.938
16	1.281	.969	.120	.150	2.125	2.500	.790	.781/.750	.290	1.0000-20 UNEF	1.0000-20 UNEF	.083	1.062
16S	1.281	.969	.120	.150	2.031	—	.790	.593/.562	.290	1.0000-20 UNEF	1.0000-20 UNEF	.083	1.062
18	1.375	1.062	.120	.177	2.125	2.500	.869	.781/.750	.290	1.0625-18 UNEF	1.1250-18 UNEF	.125	1.188
20	1.500	1.156	.120	.177	2.125	2.500	.994	.781/.750	.290	1.1875-18 UNEF	1.2500-18 UNEF	.125	1.312
22	1.625	1.250	.120	.177	2.125	2.500	1.119	.781/.750	.290	1.3125-18 UNEF	1.3750-18 UNEF	.125	1.438
24	1.750	1.375	.147	.177	2.125	2.500	1.244	.843/.812	.290	1.4375-18 UNEF	1.5000-18 UNEF	.125	1.562
28	2.000	1.562	.147	.177	2.125	2.500	1.465	.843/.812	.467	1.7500-18 UNS	1.7500-18 UNS	.125	1.812
32	2.250	1.750	.173	.209	2.125	2.500	1.715	.906/.875	.467	2.0000-18 UNS	2.0000-18 UNS	.125	2.062
36	2.500	1.938	.173	.209	2.125	2.500	1.930	.906/.875	.467	2.2500-16 UN	2.2500-16 UN	.125	2.312
40	2.750	2.188	.173	.209	2.125	2.500	2.145	.906/.875	.467	2.5000-16 UN	2.5000-16 UN	.125	2.562

\* Consult Amphenol Aerospace for availability of shell sizes 44 and 48.

38999

- III
- HD
- Dualok
- II
- I
- SJT
- Accessories
- Aquacon
- Herm/Seal
- PCB

- HIGH SPEED
- Fiber Optics
- Contacts
- Connectors
- Cables

- EMI Filter
- Transient

- 26482
- Matrix 2

- 83723 III
- Matrix | Pyle

- 26500
- Pyle

- 5015
- Crimp Rear Release
- Matrix

- 22992
- Class L

- Back-
- Shells

- Options
- Others

# MS3451, MIL-DTL-5015 Crimp Rear Release Cable Connecting Receptacle

**PART # Receptacle Shell, Cable Connecting, Threaded Coupling.**  
To complete, see how to order page 447

MIL-DTL-5015	Connector Type	Connector Style	Service Class	Shell Size- Insert Arrangement	Contact Type	Insert Rotation	Modification Number
<b>Military</b>	<b>MS</b>	<b>3451</b>	<i>L</i>	<i>16S-8</i>	<i>P</i>	<i>W</i>	<b>NA</b>
<b>Commercial</b>	<b>944</b>	<b>1</b>	<i>F</i>	<i>16S-8</i>	<i>P</i>	<i>W</i>	<i>xxx</i>

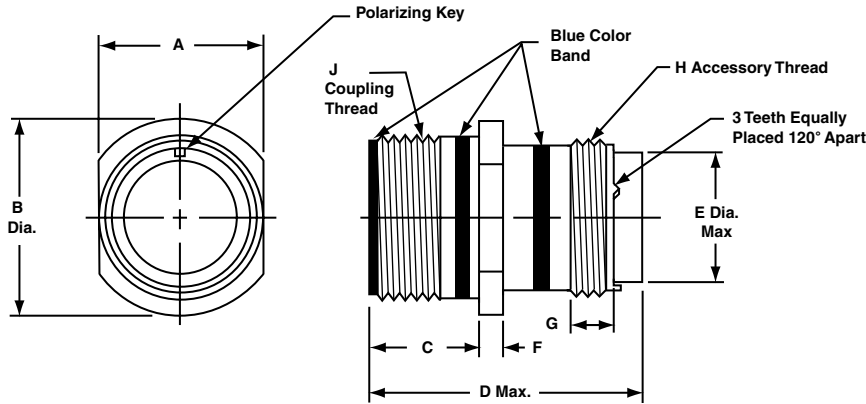

Shell Size	A	B Dia. ±.031	C	D Max.		E Dia. Max.	F ±.015	G Min.	H Thread Class 2A	J Thread Class 2A
				Size 16 & 12 Contacts	Size 8, 4, 0 Contacts					
8S	.504/.496	.729	.577/.562	2.031	—	.305	.083	.290	.5000-20 UNEF	.5000-28 UNEF
10S	.629/.621	.854	.577/.562	2.031	—	.405	.083	.290	.6250-24 UNEF	.6250-24 UNEF
10SL	.629/.621	.854	.577/.562	2.031	—	.405	.083	.290	.6250-24 UNEF	.6250-24 UNEF
12	.754/.746	.974	.765/.750	2.125	—	.549	.083	.290	.7500-20 UNEF	.7500-20 UNEF
12S	.754/.746	.974	.577/.562	2.031	—	.549	.083	.290	.7500-20 UNEF	.7500-20 UNEF
14	.879/.871	1.099	.765/.750	2.125	—	.665	.083	.290	.8750-20 UNEF	.8750-20 UNEF
14S	.879/.871	1.099	.577/.562	2.031	—	.665	.083	.290	.8750-20 UNEF	.8750-20 UNEF
16	1.005/.996	1.224	.765/.750	2.125	2.500	.790	.083	.290	1.0000-20 UNEF	1.0000-20 UNEF
16S	1.005/.996	1.224	.577/.562	2.031	—	.790	.083	.290	1.0000-20 UNEF	1.0000-20 UNEF
18	1.131/1.121	1.349	.765/.750	2.125	2.500	.869	.125	.290	1.0625-18 UNEF	1.1250-18 UNEF
20	1.256/1.246	1.474	.765/.750	2.125	2.500	.994	.125	.290	1.1875-18 UNEF	1.2500-18 UNEF
22	1.381/1.371	1.599	.765/.750	2.125	2.500	1.119	.125	.290	1.3125-18 UNEF	1.3750-18 UNEF
24	1.506/1.496	1.715	.827/.812	2.125	2.500	1.244	.125	.290	1.4375-18 UNEF	1.5000-18 UNEF
28	1.756/1.746	1.974	.827/.812	2.125	2.500	1.465	.125	.467	1.7500-18 UNS	1.7500-18 UNS
32	2.007/1.996	2.224	.890/.870	2.125	2.500	1.715	.125	.467	2.0000-18 UNS	2.0000-18 UNS
36	2.257/2.246	2.474	.890/.870	2.125	2.500	1.930	.125	.467	2.2500-16 UN	2.2500-16 UN
40	2.511/2.456	2.724	.890/.870	2.125	2.500	2.145	.125	.467	2.5000-16 UN	2.5000-16 UN

\* Consult Amphenol Aerospace for availability of shell sizes 44 and 48.

38999

- III
- HD
- Dualok
- II
- I
- SJT
- Accessories
- Aquacon
- Herm/Seal
- PCB

- HIGH SPEED
- Fiber Optics
- Contacts Connectors Cables

EMI Filter  
Transient

26482  
Matrix 2

83723 III  
Matrix | Pyle

26500  
Pyle

5015  
Crimp Rear Release  
Matrix

22992  
Class 1

Back-Shell's

Options  
Others



38999

III

HD

Dualok

II

I

SJT

Accessories

Aquacon

Herm/Seal

PCB

**HIGH SPEED**

Fiber Optics

Contacts  
Connectors  
Cables

EMI Filter  
Transient

26482  
Matrix 2

83723 III  
Matrix | Pyle

26500  
Pyle

5015  
Crimp Rear Release  
Matrix

22992  
Class I

Back-  
Shells

Options  
Others

**PART # Receptacle Shell, Flange Mount, Threaded Coupling.**  
**To complete, see how to order page 447**

MIL-DTL-5015	Connector Type	Shell Style	Service Class	Shell Size-Insert Arrangement	Contact Type	Alternate Rotation	Modification Number
<b>Military</b>	<b>MS</b>	<b>3452</b>	<i>L</i>	<i>16S-8</i>	<i>P</i>	<i>W</i>	<b>NA</b>
<b>Commercial</b>	<b>944</b>	<b>2</b>	<i>F</i>	<i>16S-8</i>	<i>P</i>	<i>W</i>	<i>xxx</i>

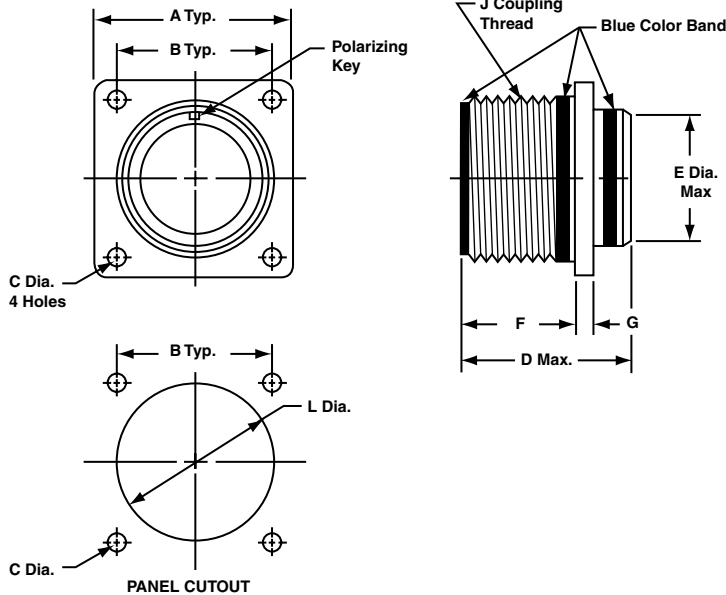

Shell Size*	A ±.031	B	C Dia.	D Max.		E Dia. ±.016	F	G ±.015	J Thread Class 2A	L Dia. ±.010
				Size 16 & 12 Contacts	Size 8, 4, 0 Contacts					
8S	.875	.594	.130/.115	1.662	—	.500	.578/.562	.083	.5000-28 UNEF	.562
10S	1.000	.719	.130/.115	1.662	—	.625	.578/.562	.083	.6250-24 UNEF	.688
10SL	1.000	.719	.130/.115	1.662	—	.625	.578/.562	.083	.6250-24 UNEF	.688
12	1.094	.812	.130/.115	1.662	—	.750	.765/.750	.083	.7500-20 UNEF	.812
12S	1.094	.812	.130/.115	1.662	—	.750	.578/.562	.083	.7500-20 UNEF	.812
14	1.188	.906	.130/.115	1.662	—	.875	.765/.750	.083	.8750-20 UNEF	.938
14S	1.188	.906	.130/.115	1.662	—	.875	.577/.562	.083	.8750-20 UNEF	.938
16	1.281	.969	.130/.115	1.662	1.937	1.000	.765/.750	.083	1.0000-20 UNEF	1.062
16S	1.281	.969	.130/.115	1.662	—	1.000	.577/.562	.083	1.0000-20 UNEF	1.062
18	1.375	1.062	.130/.115	1.662	1.937	1.062	.765/.750	.125	1.1250-18 UNEF	1.188
20	1.500	1.156	.130/.115	1.662	1.937	1.187	.765/.750	.125	1.2500-18 UNEF	1.312
22	1.625	1.250	.130/.115	1.662	1.937	1.312	.765/.750	.125	1.3750-18 UNEF	1.438
24	1.750	1.375	.157/.142	1.662	1.937	1.437	.827/.812	.125	1.5000-18 UNEF	1.562
28	2.000	1.562	.157/.142	1.662	1.937	1.750	.827/.812	.125	1.7500-18 UNS	1.812
32	2.250	1.750	.183/.168	1.662	1.937	2.000	.988/.875	.125	2.0000-18 UNS	2.062
36	2.500	1.938	.183/.168	1.662	1.937	2.250	.988/.875	.125	2.2500-16 UN	2.312
40	2.750	2.188	.183/.168	1.662	1.937	2.500	.988/.875	.125	2.5000-16 UN	2.562

\* Consult Amphenol Aerospace for availability of shell sizes 44 and 48.

# MS3454, MIL-DTL-5015 Crimp Rear Release Jam Nut Receptacle

## PART # Receptacle Shell, Jam Nut Mount, Threaded Coupling To complete, see how to order page 447

MIL-DTL-5015	Connector Type	Shell Style	Service Class	Shell Size— Insert Arrangement	Contact Type	Alternate Rotation	Modification Number
<b>Military</b>	<b>MS</b>	<b>3454</b>	<b>L</b>	<b>16S-8</b>	<b>P</b>	<b>W</b>	<b>NA</b>
<b>Commercial</b>	<b>944</b>	<b>4</b>	<b>F</b>	<b>16S-8</b>	<b>P</b>	<b>W</b>	<b>xxx</b>

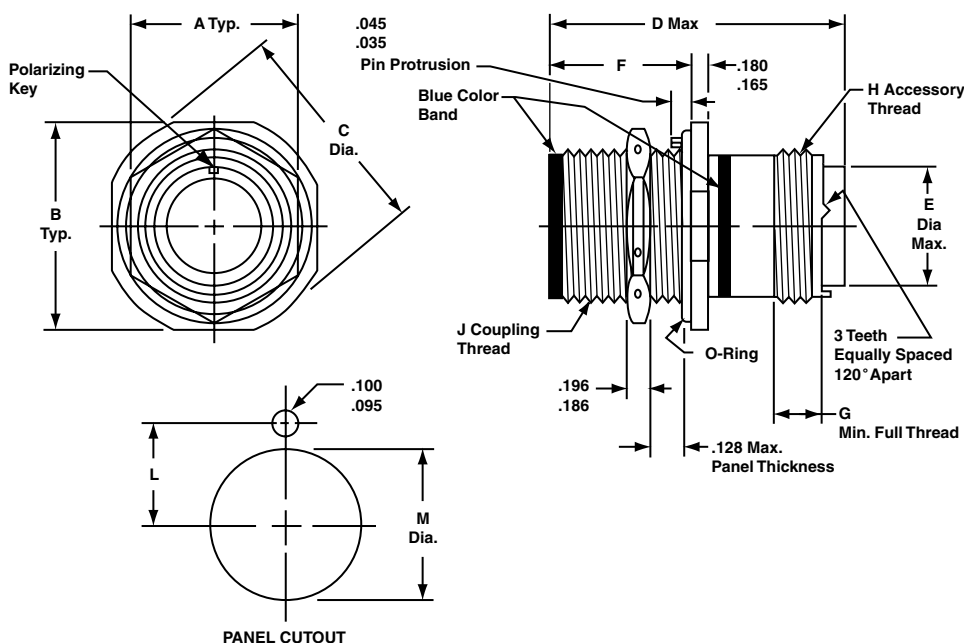

Shell Size*	A ±.010	B ±.005	C Dia. ±.005	D Max.		E Dia. Max.	F ±.005	G Min.	H Thread Class 2A	J Thread Class 2A	Panel Cutout Dimensions	
				Size 16 & 12 Contacts	Size 8, 4, 0 Contacts						L ±.005	M Dia. +.015 - .000
8S	.687	1.187	1.272	2.031	—	.305	.720	.290	.5000-20 UNEF	.5000-28 UNEF	.323	.505
10S	.812	1.312	1.397	2.031	—	.405	.720	.290	.6250-24 UNEF	.6250-24 UNEF	.385	.630
10SL	.812	1.312	1.397	2.031	—	.405	.720	.290	.6250-24 UNEF	.6250-24 UNEF	.385	.630
12	.937	1.437	1.522	2.125	—	.549	.970	.290	.7500-20 UNEF	.7500-20 UNEF	.448	.755
12S	.937	1.437	1.522	2.031	—	.549	.720	.290	.7500-20 UNEF	.7500-20 UNEF	.448	.755
14	1.125	1.562	1.647	2.125	—	.665	.970	.290	.8750-20 UNEF	.8750-20 UNEF	.510	.880
14S	1.125	1.562	1.647	2.031	—	.665	.720	.290	.8750-20 UNEF	.8750-20 UNEF	.510	.880
16	1.250	1.687	1.772	2.125	2.500	.790	.970	.290	1.0000-20 UNEF	1.0000-20 UNEF	.573	1.005
16S	1.250	1.687	1.772	2.031	—	.790	.720	.290	1.0000-20 UNEF	1.0000-20 UNEF	.573	1.005
18	1.375	1.812	1.897	2.125	2.500	.869	.970	.290	1.0625-18 UNEF	1.1250-18 UNEF	.635	1.130
20	1.500	1.937	2.022	2.125	2.500	.994	.970	.290	1.1875-18 UNEF	1.2500-18 UNEF	.698	1.255
22	1.625	2.156	2.241	2.125	2.500	1.119	.970	.290	1.3125-18 UNEF	1.3750-18 UNEF	.760	1.380
24	1.750	2.281	2.366	2.125	2.500	1.244	.970	.290	1.4375-18 UNEF	1.5000-18 UNEF	.823	1.505
28	2.000	2.531	2.616	2.125	2.500	1.465	.970	.467	1.7500-18 UNS	1.7500-18 UNS	.948	1.755
32	2.375	2.781	2.866	2.125	2.500	1.715	.970	.467	2.0000-18 UNS	2.0000-18 UNS	1.073	2.005
36	2.625	3.031	3.116	2.125	2.500	1.930	.970	.467	2.2500-16 UN	2.2500-16 UN	1.198	2.255
40	2.875	3.281	3.366	2.125	2.500	2.145	.970	.467	2.5000-16 UN	2.5000-16 UN	1.323	2.505

\* Consult Amphenol Aerospace for availability of shell sizes 44 and 48.

38999

- III
- HD
- Dualok
- II
- I
- SJT
- Accessories
- Aquacon
- Herm/Seal
- PCB

HIGH SPEED

- Fiber Optics
- Contacts
- Connectors
- Cables

EMI Filter  
Transient

26482  
Matrix 2

83723 III  
Matrix | Pyle

26500  
Pyle

5015  
Crimp Rear Release  
Matrix

22992  
Class 1

Back-Shell's

Options  
Others

38999  
III  
HD  
Dualok  
II  
I  
SJT  
Accessories  
Aquacon  
Herm/Seal  
PCB

HIGH SPEED  
Fiber Optics  
Contacts  
Connectors  
Cables

EMI Filter  
Transient

26482  
Matrix 2

83723 III  
Matrix | Pyle

26500  
Pyle

5015  
Crimp Rear Release  
Matrix

22992  
Class I

Back-  
Shells

Options  
Others

**PART # Plug Shell, Threaded Coupling.**  
**To complete, see how to order page 447**

MIL-DTL-5015	Connector Type	Shell Style	Service Class	Shell Size-Insert Arrangement	Contact Type	Alternate Rotation	Modification Number
<b>Military</b>	<b>MS</b>	<b>3456</b>	<i>L</i>	<i>16S-8</i>	<i>P</i>	<i>W</i>	<b>NA</b>
<b>Commercial</b>	<b>944</b>	<b>6</b>	<i>F</i>	<i>16S-8</i>	<i>P</i>	<i>W</i>	<i>xxx</i>

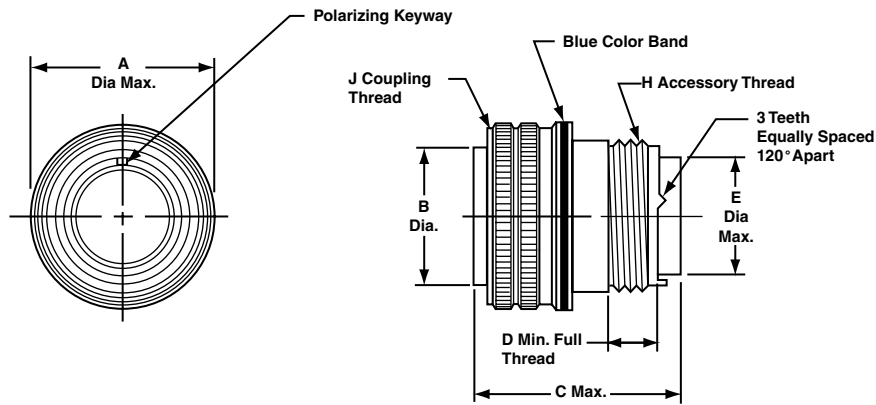

Shell Size*	A Dia. Max.	B Dia. ±.005	C Max.		D Min.	E Dia. Max.	H Thread Class 2A	J Thread Class 2B
			Size 16 & 12 Contacts	Size 8, 4, 0 Contacts				
8S	.844	.360	2.031	—	.290	.305	.5000-20 UNF	.5000-28 UNEF
10S	.969	.435	2.031	—	.290	.405	.6250-24 UNEF	.6250-24 UNEF
10SL	.969	.441**	2.031	—	.290	.405	.6250-24 UNEF	.6250-24 UNEF
12	1.062	.550	2.125	—	.290	.549	.7500-20 UNEF	.7500-20 UNEF
12S	1.062	.550	2.031	—	.290	.549	.7500-20 UNEF	.7500-20 UNEF
14	1.156	.670	2.125	—	.290	.665	.8750-20 UNEF	.8750-20 UNEF
14S	1.156	.670	2.031	—	.290	.665	.8750-20 UNEF	.8750-20 UNEF
16	1.250	.800	2.125	2.500	.290	.790	1.0000-20 UNEF	1.0000-20 UNEF
16S	1.250	.800	2.031	—	.290	.790	1.0000-20 UNEF	1.0000-20 UNEF
18	1.344	.925	2.125	2.500	.290	.869	1.0625-18 UNEF	1.1250-18 UNEF
20	1.469	1.045	2.125	2.500	.290	.994	1.1875-18 UNEF	1.2500-18 UNEF
22	1.594	1.170	2.125	2.500	.290	1.119	1.3125-18 UNEF	1.3750-18 UNEF
24	1.719	1.295	2.125	2.500	.290	1.244	1.4375-18 UNEF	1.5000-18 UNEF
28	1.969	1.515	2.125	2.500	.467	1.465	1.7500-18 UNS	1.7500-18 UNS
32	2.219	1.765	2.125	2.500	.467	1.715	2.0000-18 UNS	2.0000-18 UNS
36	2.469	1.975	2.125	2.500	.467	1.930	2.2500-16 UN	2.2500-16 UN
40	2.719	2.225	2.125	2.500	.467	2.145	2.5000-16 UN	2.5000-16 UN

\* Consult Amphenol Aerospace for availability of shell sizes 44 and 48.  
\*\* Tolerance on this dimension is +.000 –.006

# MS3459, MIL-DTL-5015 Crimp Rear Release Straight Plug with Self-locking Coupling Nut

**PART # Plug Shell, Self-Locking, Threaded Coupling**  
To complete, see how to order page 447

MIL-DTL-5015	Connector Type	Shell Style	Service Class	Shell Size-Insert Arrangement	Contact Type	Alternate Rotation	Modification Number
<b>Military</b>	<b>MS</b>	<b>3459</b>	<i>L</i>	<i>16S-8</i>	<i>P</i>	<i>W</i>	<b>NA</b>
<b>Commercial</b>	<b>981</b>	<b>6</b>	<i>F</i>	<i>16S-8</i>	<i>P</i>	<i>W</i>	<i>xxx</i>

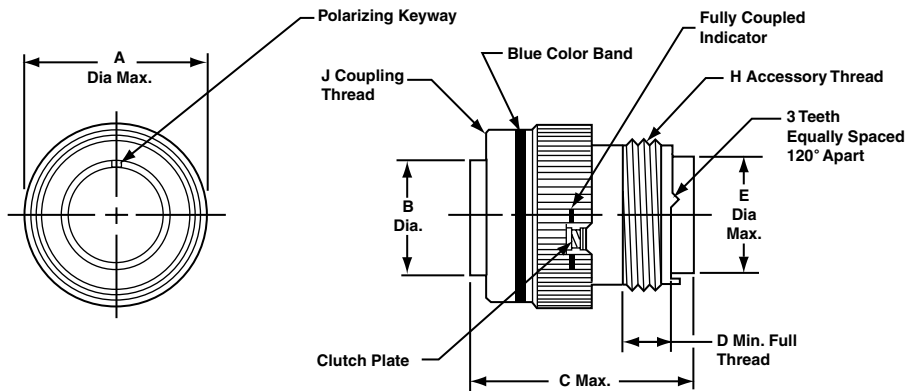

Shell Size*	A Dia. Max.	B Dia. ±.005	C Max.		D Min.	E Dia. Max.	H Thread Class 2A	J Thread Class 2B
			Size 16 & 12 Contacts	Size 8, 4, 0 Contacts				
8S	.963	.360	1.510	-	.290	.305	.5000-20 UNEF	.5000-28 UNEF
10S	1.088	.435	1.510	-	.290	.405	.6250-24 UNEF	.6250-24 UNEF
10SL	1.088	.441**	1.510	-	.290	.405	.6250-24 UNEF	.6250-24 UNEF
12	1.213	.550	1.780	-	.290	.549	.7500-20 UNEF	.7500-20 UNEF
12S	1.213	.550	1.510	-	.290	.549	.7500-20 UNEF	.7500-20 UNEF
14	1.358	.670	1.780	-	.290	.665	.8750-20 UNEF	.8750-20 UNEF
14S	1.358	.670	1.510	-	.290	.665	.8750-20 UNEF	.8750-20 UNEF
16	1.463	.800	1.780	2.500	.290	.790	1.0000-20 UNEF	1.0000-20 UNEF
16S	1.463	.800	1.510	-	.290	.790	1.0000-20 UNEF	1.0000-20 UNEF
18	1.588	.925	1.850	2.500	.290	.869	1.0625-18 UNEF	1.1250-18 UNEF
20	1.713	1.045	1.850	2.500	.290	.994	1.1875-18 UNEF	1.2500-18 UNEF
22	1.788	1.170	1.850	2.500	.290	1.119	1.3125-18 UNEF	1.3750-18 UNEF
24	1.963	1.295	1.850	2.500	.290	1.244	1.4375-18 UNEF	1.5000-18 UNEF
28	2.213	1.515	1.850	2.500	.467	1.465	1.7500-18 UNS	1.7500-18 UNS
32	2.463	1.765	1.850	2.500	.467	1.715	2.0000-18 UNS	2.0000-18 UNS
36	2.713	1.975	1.850	2.500	.467	1.930	2.2500-16 UN	2.2500-16 UN
40	2.963	2.225	1.850	2.500	.467	2.145	2.5000-16 UN	2.5000-16 UN

\* Consult Amphenol Aerospace for availability of shell sizes 44 and 48.  
\*\* Tolerance on this dimension is +.000 - .006

38999

- III
- HD
- Dualok
- II
- I
- SJT
- Accessories
- Aquacon
- Herm/Seal
- PCB

- HIGH SPEED
- Fiber Optics
- Contacts Connectors Cables

EMI Filter Transient

26482 Matrix 2

83723 III Matrix | Pyle

26500 Pyle

5015 Crimp Rear Release Matrix

22992 Class 1

Back-Shell's

Options Others

**PART # Plug Shell, Quick Disconnect, Push-pull Coupling**  
To complete, see how to order page 447

MIL-DTL-5015	Connector Type	Shell Style	Service Class	Shell Size— Insert Arrangement	Contact Type	Alternate Rotation	Modification Number
Commercial	981	7	L	16S-8	P	W	xxx
Commercial	981	8	F	16S-8	P	W	xxx

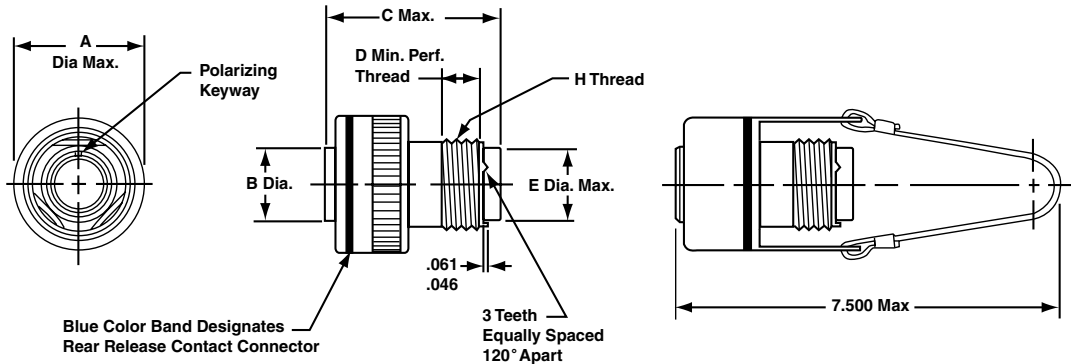

9818 Connector

9817 Connector with Lanyard

Shell Size*	A Dia. Max.	B Dia.	C Max.		D Min.	E Dia. Max.	H Thread Class 2A	Amphenol/ Matrix Part Number for Adapter Ring
			Size 16 & 12 Contacts	Size 8, 4, 0 Contacts				
8S	1.087	.360	2.031	—	.290	.305	.5000-20 UNF	2500-008-0X08
10S	1.224	.435	2.031	—	.290	.405	.6250-24 UNEF	2500-008-0X10
10SL	1.224	.441	2.031	—	.290	.405	.6250-24 UNEF	2500-008-0X10
12	1.355	.550	2.125	—	.290	.549	.7500-20 UNEF	2500-008-0X12
12S	1.355	.550	2.031	—	.290	.549	.7500-20 UNEF	2500-008-0X13
14	1.482	.670	2.125	—	.290	.665	.8750-20 UNEF	2500-008-0X14
14S	1.482	.670	2.031	—	.290	.665	.8750-20 UNEF	2500-008-0X15
16	1.609	.800	2.125	2.500	.290	.790	1.0000-20 UNEF	2500-008-0X16
16S	1.609	.800	2.031	—	.290	.790	1.0000-20 UNEF	2500-008-0X17
18	1.817	.925	2.125	2.500	.290	.869	1.0625-18 UNEF	2500-008-0X18
20	1.942	1.045	2.125	2.500	.290	.994	1.1875-18 UNEF	2500-008-0X20
22	2.075	1.170	2.125	2.500	.290	1.119	1.3125-18 UNEF	2500-008-0X22
24	2.203	1.295	2.125	2.500	.290	1.244	1.4375-18 UNEF	2500-008-0X24
28	2.516	1.515	2.125	2.500	.467	1.465	1.7500-18 UNS	2500-008-0X28
32	2.735	1.765	2.125	2.500	.467	1.715	2.0000-18 UNS	2500-008-0X32
36	3.015	1.975	2.125	2.500	.467	1.930	2.2500-16 UN	2500-008-0X36
40	3.306	2.225	2.125	2.500	.467	2.145	2.5000-16 UN	2500-008-0X40

\* Consult Amphenol Aerospace for availability of shell sizes 44 and 48.

**Receptacle Adapter Ring**

Required to mate the quick disconnect plug with receptacle. Not furnished with the quick disconnect plug and must be ordered separately.

Note: Use Locktite Material on the threads for a permanent installation to the shell.

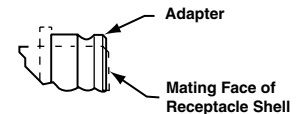

**How to Order Adapter Ring**

**Part Number**

**2500-008-0 X XX**

Shell Size (varies from connector shell size designation, see last column of table at left)

- Finish
- 0 - Electroless Nickel
  - 1 - Black Anodize
  - 2 - Cadmium/Olive Drab
  - 3 - Stainless Steel, Passivated

38999

III

HD

Dualok

II

I

SJT

Accessories

Aquacon

Herm/Seal

PCB

**HIGH SPEED**

Fiber Optics

Contacts  
Connectors  
Cables

EMI Filter  
Transient

26482  
Matrix 2

83723 III  
Matrix | Pyle

26500  
Pyle

5015  
Crimp Rear Release Matrix

22992  
Class I

Back-  
Shells

Options  
Others



# Amphenol® Matrix 5015 Connector With RADSOK® Contacts

## For High Power Applications

- Mil-spec qualified, environmental Matrix MIL-DTL-5015 connectors with improved sealing
- Completely environmentally sealed with contact seals, gaskets, wire seals and insert-to-shell seals
- Special design enhanced with RADSOK contacts in the plug instead of standard rear release crimp contacts
- All the shell styles and finishes of the Matrix 5015 family are available, including firewall styles and non-decoupling styles

RADSOK contacts provide high amperage capability with minimal voltage loss and low insertion forces.

The RADSOK contact has a hyperbolic, stamped grid configuration with the socket circular. As a male pin is inserted, axial members in the female socket deflect, enabling high current flow across the connection with minimal voltage loss.

See pages 561-563 for more information on RADSOK contacts.



38999

III

HD

Dualok

II

I

SJT

Accessories

Aquacon

Herm/Seal

PCB

HIGH  
SPEED

Fiber  
Optics

Contacts  
Connectors  
Cables

EMI Filter  
Transient

26482  
Matrix 2

83723 III  
Matrix | Pyle

26500  
Pyle

5015  
Crimp Rear  
Release  
Matrix

22992  
Class 1

Back-  
Shells

Options  
Others

38999  
III  
HD  
Dualok  
II  
I  
SJT  
Accessories  
Aquacon  
Herm/Seal  
PCB  
HIGH SPEED  
Fiber Optics  
Contacts Connectors Cables  
EMI Filter Transient  
26482 Matrix 2  
83723 III Matrix | Pyle  
26500 Pyle  
5015 Crimp Rear Release Matrix  
22992 Class I  
Back-Shells  
Options Others

**MS/STANDARD CRIMP REAR RELEASE CONTACTS**

Contact Size	Wire Range		Socket Contacts		Pin Contacts	
	AWG	mm <sup>2</sup>	Military Part Number	Amphenol/Matrix Part Number	Military Part Number	Amphenol/Matrix Part Number
16S*	20-16	0.5-1.4	M39029/30-217	M5100-033-1601L	M39029/29-212	M5000-029-0016L
16	20-16	0.5-1.4	M39029/30-218	M5100-033-1602L	M39029/29-212	M5000-029-0016L
12	14-12	2-3	M39029/30-219	M5100-033-0012	M39029/29-213	M5000-029-0012
8	10-8†	5-8.5	M39029/30-220	M5100-033-0008	M39029/29-214	M5000-029-0008
4	6-4†	13-21	M39029/30-221	M5100-033-0004	M39029/29-215	M5000-029-0004
0	2-0†	34-60	M39029/30-222	M5100-033-0000	M39029/29-216	M5000-029-0000

\* Shorter wire barrel      Note: For information on thermocouple contacts, consult Amphenol Aerospace  
† Use MS3348 bushing kit to accommodate smaller wire.

**CONTACT CURRENT RATING AND RETENTION**

Contact Size**	Current Rating		Contact Retention	
	Amperes Max.	Voltage Drop Millivolts	Axial Load	
			lb.	N
16	13	50	25	111.2
12	23	50	30	133.4
8	46	25	50	222.4
4	80	14	60	266.9
0	150	12	75	333.6

\*\* Organize individual circuits to maintain heat rise within operating temperature requirements.

**SEALING PLUGS**

Contact Size	Sealing Plugs	
	Military Part Number	Amphenol/Matrix Part Number
16S	MS27488-16-3	10-405996-163
16	MS27488-16-3	10-405996-163
12	MS27488-12-3	10-405996-123
8	MS27488-8-3	10-405996-083
4	MS27488-4-3	10-405996-043
0	MS27488-0-3	10-405996-003

**CRIMPING TOOLS**

Contact Size	Wire Range		Finished Wire Dia. Range		Color Code	Crimping Tool Part Number	Turret or Positioner Part Number
	AWG	mm <sup>2</sup>	Inch	mm			
16S	20-16	0.5-1.4	.053-.103	1.34-2.62	Red/White	M22520/1-01	M22520/1-02
16	20-16	0.5-1.4	.053-.103	1.34-2.62	Blue/White	M22520/1-01	M22520/1-02
12	14-12	2-3	.085-.158	2.15-4.01	Yell./White	M22520/1-01	M22520/1-02
8	10-8	5-8.5	.132-.255	3.35-6.48	White/Red	M22520/23-01	M22520/23-02
4	6-4	13-21	.237-.370	6.01-9.40	White/Blue	M22520/23-01	M22520/23-04
0	2-0	34-60	.360-.550	9.14-13.97	White/Yell.	M22520/23-01	M22520/23-05

**INSERTION/REMOVAL TOOLS**

Contact Size	Color Code	Military Part Number	Amphenol/Matrix Part Number
16	Blue/White	M81969/14-03	10-538988-016
12	Yellow/White	M81969/14-04	10-538988-012
8	Red	M81969/14-06	6500-018-0008
4	Blue	M81969/14-07	6500-018-0004
0	Yellow	M81969/14-08	6500-018-0000

Amphenol installation instructions, L-2106, gives information on insertion, removal and crimping of contacts for Matrix MIL-DTL-5015 connectors.

**BACKSHELLS**

The section of this catalog called "Backshells" covers the backshells for MIL-DTL-5015 that are provided through Amphenol PCD. Please refer to this section for:  
• Backshells for Connector Family "J", which includes MIL-DTL-26482 (Series II), MIL-DTL-5015 (MS3400), MIL-DTL-83723 (Series I & III).

### PLUG PROTECTION CAP 10-329393-XX\*

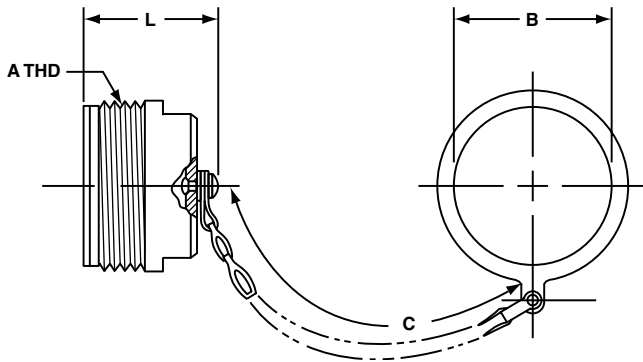

Assembly Number	A Thread Class 2A	B Dia. +.010 - .000	C Approx.	L Max.
10-329393-10	.625-24UNEF	.641	3.5	1.312
10-329393-11	.625-24UNEF	.641	3.5	1.312
10-329393-12	.750-20UNEF	.766	3.5	1.500
10-329393-14	.875-20UNEF	.891	3.5	1.500
10-329393-16	1.000-20UNEF	1.016	3.5	1.500
10-329393-18	1.125-18UNEF	1.141	3.5	1.500
10-329393-20	1.250-18UNEF	1.266	4.0	1.500
10-329393-22	1.375-18UNEF	1.391	4.0	1.500
10-329393-24	1.500-18UNEF	1.641	4.5	1.500
10-329393-28	1.750-18UNS	1.891	4.5	1.500
10-329393-32	2.000-18UNS	2.078	5.0	1.500
10-329393-36	2.250-16UN	2.328	5.0	1.500
10-329393-40	2.500-16UN	2.641	5.0	1.500
10-329393-44	2.750-16UN	2.891	6.0	1.500

### PLUG PROTECTION CAP 10-229125-XX\*

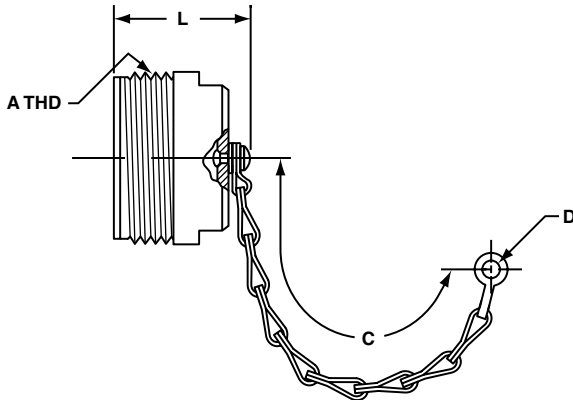

Assembly Number	A Thread Class 2A	C Approx.	D Ref.	L Max.
10-229125-10	.625-24NEF	3.0	.140	1.233
10-229125-12	.750-20UNEF	3.5	.140	1.421
10-229125-14	.875-20UNEF	3.5	.140	1.421
10-229125-16	1.000-20UNEF	3.5	.140	1.421
10-229125-18	1.125-18NEF	3.5	.140	1.421
10-229125-20	1.250-18NEF	3.5	.193	1.421
10-229125-22	1.375-18NEF	3.5	.193	1.421
10-229125-24	1.500-18NEF	4.5	.193	1.421
10-229125-28	1.750-18NS	4.5	.193	1.421
10-229125-32	2.000-18NS	5.0	.193	1.421
10-229125-36	2.250-16UN	5.0	.193	1.421
10-229125-40	2.500-16UN	5.0	.193	1.421

### PLUG PROTECTION CAP MS25042-XXDA\*

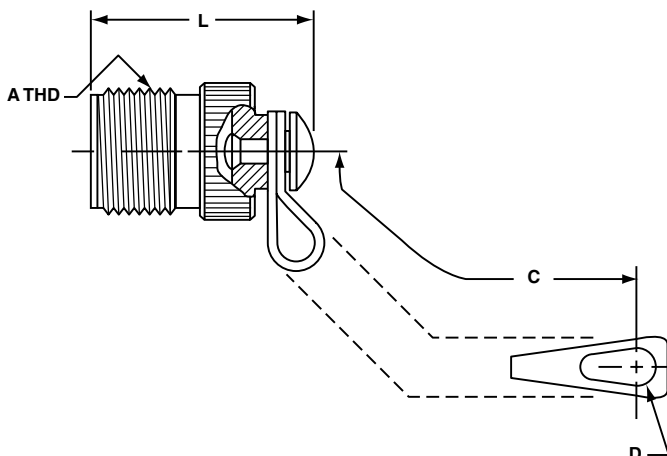

MS Number	A Thread Class 2A	B Dia. +.010 - .005	C Approx.	L Max.
MS25042-8DA	.500-28UNEF	.156	4.00	.969
MS25042-10DA	.625-24UNEF	.156	4.00	.969
MS25042-12DA	.750-20UNEF	.156	4.50	1.156
MS25042-14DA	.875-20UNEF	.156	4.50	1.156
MS25042-16DA	1.000-20UNEF	.156	4.50	1.156
MS25042-18DA	1.125-18UNEF	.156	4.50	1.156
MS25042-20DA	1.250-18UNEF	.187	5.00	1.156
MS25042-22DA	1.375-18UNEF	.187	5.00	1.156
MS25042-24DA	1.500-18UNEF	.187	5.50	1.156
MS25042-28DA	1.750-18UNS	.187	7.75	1.156
MS25042-32DA	2.000-18UNS	.218	7.75	1.156
MS25042-36DA	2.250-16UN	.218	7.75	1.156
MS25042-40DA	2.500-16UN	.218	7.75	1.156

\* Protective caps are illustrated with sash chains and are available with beaded chains or without chains. Optional terminations are also available. Consult Amphenol Aerospace when ordering.

38999

III  
HD  
Dualok  
II  
I  
SJT  
Accessories  
Aquacon  
Herm/Seal  
PCB

HIGH SPEED  
Fiber Optics  
Contacts  
Connectors  
Cables

EMI Filter  
Transient  
Matrix 1  
26482  
Matrix 2  
83723  
III  
Pyle  
26500  
Pyle

5015  
Crmp Rear  
Release  
Matrix  
22992  
Class 1  
Back-  
Shells  
Options  
Others

38999

- III
- HD
- Dualok
- II
- I
- SJT
- Accessories
- Aquacon
- Herm/Seal
- PCB

HIGH SPEED

- Fiber Optics
- Contacts
- Connectors
- Cables

EMI Filter Transient

26482 Matrix 2

83723 III Matrix | Pyle

26500 Pyle

5015 Crimp Rear Release Matrix

22992 Class I

Back-Shells

Options Others

Assembly Number	A Thread Class 2B	B Dia. Min.	C Approx.	D Dia. Max.	L Max.
10-329394-10	.625-24UNEF	.641	3.5	.875	.793
10-329394-12	.750-20UNEF	.766	3.5	1.000	.793
10-329394-14	.875-20UNEF	.891	3.5	1.125	.793
10-329394-16	1.000-20UNEF	1.016	3.5	1.250	.793
10-329394-18	1.125-18UNEF	1.141	3.5	1.375	1.024
10-329394-20	1.250-18UNEF	1.266	4.0	1.500	1.024
10-329394-22	1.375-18UNEF	1.391	4.0	1.625	1.024
10-329394-24	1.500-18UNEF	1.641	4.5	1.750	1.024
10-329394-28	1.750-18UNS	1.891	4.5	2.000	1.024
10-329394-32	2.000-18UNS	2.078	5.0	2.250	1.024
10-329394-36	2.250-16UN	2.328	5.0	2.500	1.024
10-329394-40	2.500-16UN	2.641	5.0	2.656	1.024
10-329394-44	2.750-16UN	2.891	6.0	2.938	1.024

Assembly Number	A Thread Class 2B	B Ref.	C Approx.	D Dia. Max.	L Max.
10-422905-103	.625-24UNEF	.140	3.0	.875	.812
10-422905-123	.750-20UNEF	.140	3.5	1.000	.812
10-422905-143	.875-20UNEF	.140	3.5	1.125	.812
10-422905-163	1.000-20UNEF	.140	3.5	1.250	.812
10-422905-183	1.125-18UNEF	.193	3.5	1.375	1.031
10-422905-203	1.250-18UNEF	.193	4.0	1.500	1.031
10-422905-223	1.375-18UNEF	.193	4.0	1.625	1.031
10-422905-243	1.500-18UNEF	.193	4.5	1.750	1.031
10-422905-283	1.750-18UNS	.193	4.5	2.000	1.031
10-422905-323	2.000-18UNS	.193	5.0	2.250	1.031
10-422905-363	2.250-16UN	.193	5.0	2.500	1.031
10-422905-403	2.500-16UN	.193	5.0	2.656	1.031

MS Number	A Thread Class 2B	B +.010 - .005	C Approx.	D Dia. Max.	L Max.
MS25043-8DA	.500-28UNEF	.140	4.00	.688	.750
MS25043-10DA	.625-24UNEF	.140	4.00	.815	.750
MS25043-12DA	.750-20UNEF	.140	4.50	1.000	.750
MS25043-14DA	.875-20UNEF	.140	4.50	1.125	.750
MS25043-16DA	1.000-20UNEF	.140	4.50	1.188	.750
MS25043-18DA	1.125-18UNEF	.140	4.50	1.344	.750
MS25043-20DA	1.250-18UNEF	.140	5.00	1.469	.750
MS25043-22DA	1.375-18UNEF	.140	5.00	1.594	.750
MS25043-24DA	1.500-18UNEF	.171	5.50	1.719	.750
MS25043-28DA	1.750-18UNS	.171	7.75	1.969	.812
MS25043-32DA	2.000-18UNS	.187	7.75	2.219	.812
MS25043-36DA	2.250-16UN	.187	7.75	2.469	.812
MS25043-40DA	2.500-16UN	.187	7.75	2.719	.812

### RECEPTACLE PROTECTION CAP 10-329394-XX\*

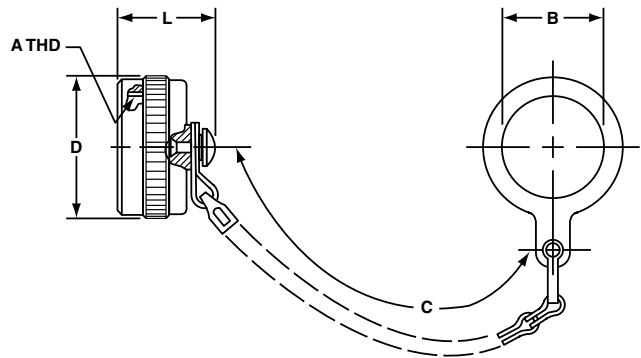

### RECEPTACLE PROTECTION CAP 10-422905-XXX\*

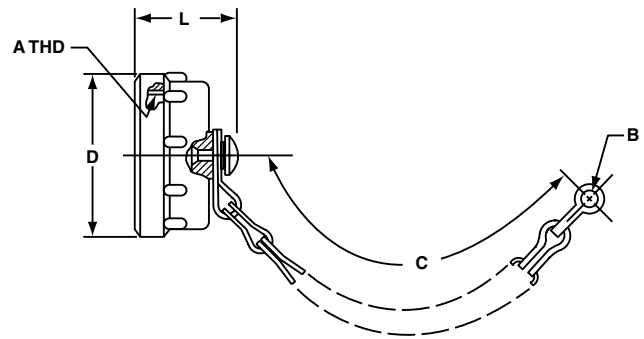

### RECEPTACLE PROTECTION CAP MS25043-XXDA\*

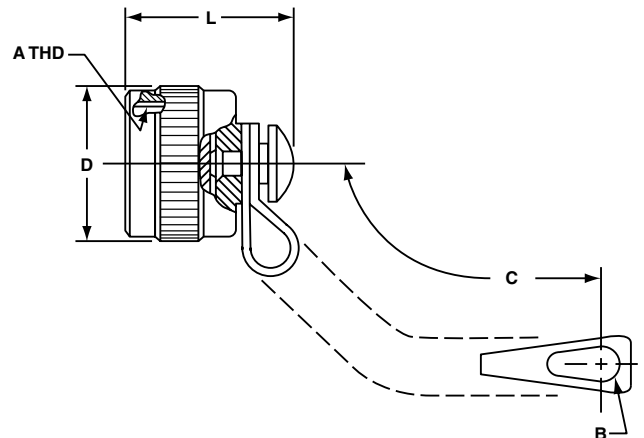

\* Protective caps are illustrated with sash chains and are available with beaded chains or without chains. Optional terminations are also available. Consult Amphenol Aerospace when ordering.

### 10-70500 RECEPTACLE DUST CAP for external threads

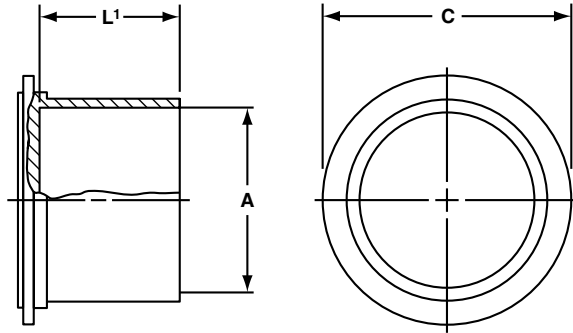

MS Shell Size	Order Number	A Dia. Nominal Thread	C Dia. ±.031	L' ±.062
8S	10-70500-8	.500	.750	.500
10S	10-70500-10	.625	.875	.500
10SL	10-70500-10	.625	.875	.500
12S	10-70500-12	.750	1.000	.500
12	10-70500-12	.750	1.000	.500
14S	10-70500-14	.875	1.125	.500
14	10-70500-14	.875	1.125	.500
16S	10-70500-16	1.000	1.250	.500
16	10-70500-16	1.000	1.250	.500
18	10-70500-18	1.125	1.375	.562
20	10-70500-20	1.250	1.500	.562
22	10-70500-22	1.375	1.625	.562
24	10-70500-24	1.500	1.750	.562
28	10-70500-28	1.750	1.938	.562
32	10-70500-32	2.000	2.250	.562
36	10-70500-36	2.250	2.500	.625
40	10-70500-40	2.500	2.750	.625

### 10-70506 PLUG DUST CAP for internal threads

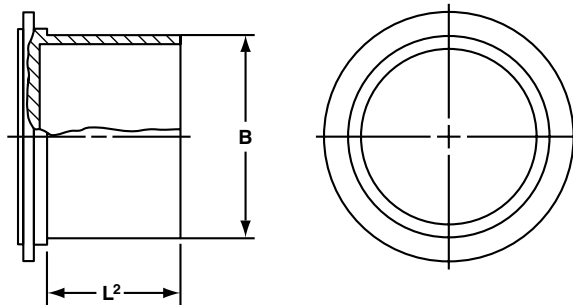

MS Shell Size	Order Number	B Dia. Min.	L <sup>2</sup> ±.125
8S	10-70506-8S	.469	.625
10S	10-70506-10S	.587	.625
10SL	10-70506-10S	.587	.625
12S	10-70506-12	.704	.625
12	10-70506-12	.704	.625
14S	10-70506-14	.828	.625
14	10-70506-14	.828	.625
16S	10-70506-16	.953	.625
16	10-70506-16	.953	.625
18	10-70506-18	1.072	.625
20	10-70506-20	1.197	.625
22	10-70506-22	1.322	.625
24	10-70506-24	1.447	.625
28	10-70506-28	1.697	.625
32	10-70506-32	1.947	.625
36	10-70506-36	2.190	.625
40	10-70506-40	2.440	.625

38999

III  
HD  
Dualok  
II  
I  
SJT  
Accessories  
Aquacon  
Herm/Seal  
PCB

HIGH SPEED  
Fiber Optics  
Contacts  
Connectors  
Cables

EMI Filter  
Transient

26482  
Matrix 2

83723 III  
Matrix | Pyle

26500  
Pyle

5015  
Crimp Rear  
Release  
Matrix

22992  
Class 1

Back-  
Shells

Options  
Others

38999

- III
- HD
- Dualok
- II
- I
- SJT
- Accessories
- Aquacon
- Herm/Seal
- PCB

- HIGH SPEED**
- Fiber Optics
- Contacts
- Connectors
- Cables

- EMI Filter
- Transient

- 26482
- Matrix 2

- 83723 III
- Matrix | Pyle

- 26500
- Pyle

- 5015
- Crimp Rear Release Matrix

- 22992
- Class 1

- Back-Shells

- Options
- Others



**MS/Standard 3100 Series, MIL-5015 Type Connectors**

**MIL-DTL-5015 and MIL-5015 Type Standard Circular Connectors with solder or crimp (non-rear release) contacts**

Amphenol has long been the accepted leader in providing MS Standard MIL-5015 type connectors. These connectors represent well-proven electrical capability at an economical cost for most equipment where durability is important.

The MS/Standard family of connectors (3100 Series) is a very broad range of product with the following features:

- Medium to heavy weight cylindrical with resilient inserts
- Environmental resistant
- Threaded couplings, single key/keyway shell polarization
- Operating voltage to 3000 VAC (RMS) at sea level
- 5 shell styles, 19 shell sizes, 280 contact arrangements
- Solder or crimp contacts (non-rear-release type), sizes 16–0 accepting 22–0 AWG
- Coaxial or thermocouple contact options
- Alternate insert positioning
- Hermetic configurations available
- Zinc alloy plating (cadmium-free) available

The 3100 Series has five classes of connectors to meet different requirements. Within these connector styles, MIL-C-5015 has been replaced as follows: Environmental classes F and R are updated to and produced in strict accordance to MIL-DTL-5015. Classes A, C and E are still produced, but are no longer listed on the qualified products listing (QPL). Class designations and brief descriptions are as follows:

A – Solid Shell – for general, non-environmental applications.

C – Pressurized – for use on pressurized bulkheads or pressure barriers; limits air leakage regardless of type and class of plug mated with them.

E/F – Environmental Resisting with Strain Relief – designed for applications where the connector will be exposed to moisture, vibration, and rapid changes in pressure and temperature.

R – Lightweight Environmental Resisting – shorter in length, lighter in weight than the E & F classes, the MS-R offers a high degree of reliability under adverse conditions: recommended for new design applications.

Ask for Amphenol catalog 12-020 which gives detailed information on this family of connectors or visit [www.amphenol-industrial.com](http://www.amphenol-industrial.com)

**MIL-5015 Modifications**

In order to supplement standard MS shell styles and provide a greater variety of styles for the electrical connector user, there are several MS and MS Modified cylindrical connectors offered by Amphenol. These types include flange mount plugs, thru bulkhead receptacles, jam nut receptacles, connectors for potting and connectors designed specifically to terminate jacketed cable. Ask for Amphenol catalog 12-021 for detailed information or visit [www.amphenol-industrial.com](http://www.amphenol-industrial.com).

**97 Series, MIL-5015 Type Connectors**

The low cost, general duty connector used extensively in the machine tool industry, welding industry and numerous other industrial applications, is the Amphenol® 97 Series. Offered in non-environmental styles, these connectors have hard dielectric inserts and threaded coupling. They are Underwriters Laboratories Recognized and Canadian Standards Association Certified.

Recent addition to this family is the 97E environmental styles, still an economical choice. The 97E can be used in a variety of industrial applications where environmental sealing is required, such as automotive and robotics.

Ask for Amphenol catalog 12-022 for detailed information or visit [www.amphenol-industrial.com](http://www.amphenol-industrial.com).



**97 Series, MIL-5015 Type Connectors**